







## 300x320 GH-LR

	0°	45°	60°	45°	60°	$\frac{h}{a \times b}$
◎	300	300	200	240	x	x
●	180*	110*	80*	110*	x	x
▭	320x300	300x250	200x200	260x200	x	230x120

					
3x400V	1,4/2,0	35/70	3660x27x0,9		548
L	B	Hmin	Hmax	V	
2270	1170	2040	1410	800	

\*doporučené hodnoty/recommended values

300-M2V

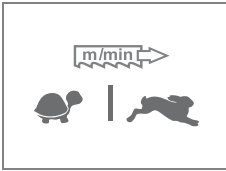

LIGHT L1

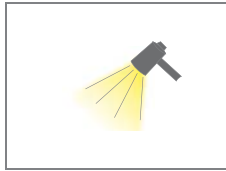

240-CK

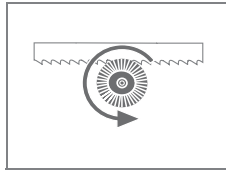

290-RP

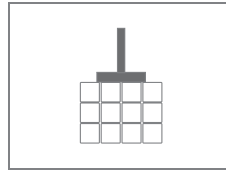

MINI LUBE

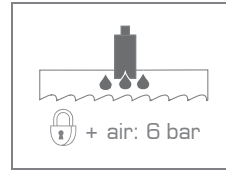

R 390

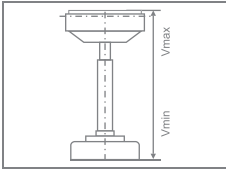

	S (mm)	Vmin (mm)	Vmax (mm)
<b>R</b>	390	760	980

OZD 1000  
OZD 2000  
OZD 3000  
OZD 4000  
OZD 5000  
OZD 6000

OZ 1000  
OZ 2000  
OZ 3000  
OZ 4000  
OZ 5000  
OZ 6000

OZ 0000



RB 200

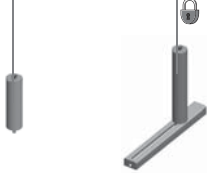

RBS 200/390  
+RB



RHS 390  
+RBS+RB

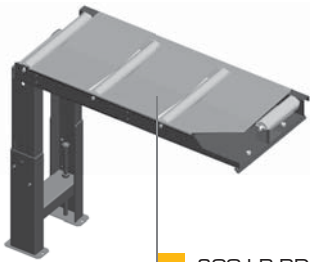

300-LR-RDP

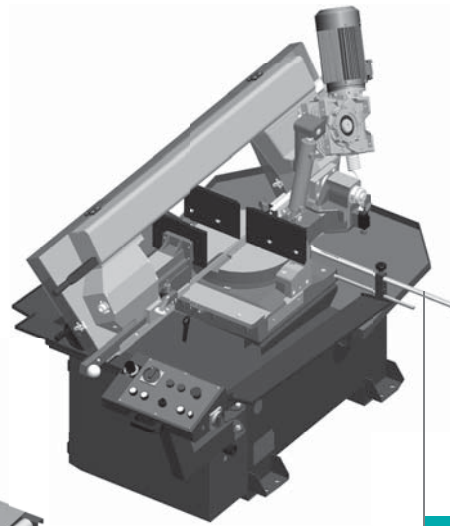

300-SRZ-R



RD VR-390

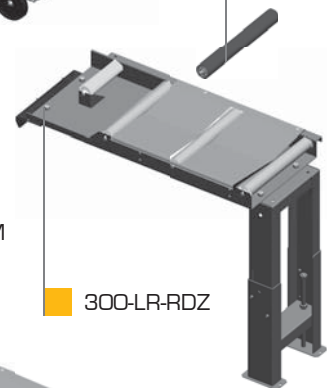

OZM

300-LR-RDZ



RD 2000/390

BOX-PCS

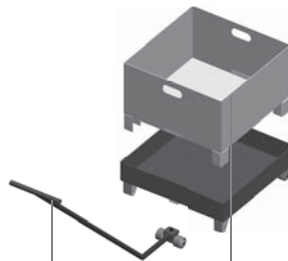

BOX-TAH

BOX-TRI

RD 1000/390



RDN

## 300x320 GH-LR

STANDARD

OPTION

**PEGAS**

PEGAS-GONDA s.r.o., Čs.armády 322, 684 01 Slavkov u Brna, CZECH REPUBLIC  
Tel: 00420-544 221 125 (126), Fax: 00420-544 227 389, E-mail: pegas@gonda.cz  
www.pegas-gonda.cz

- výrobce si vyhrazuje právo provádět změny technických údajů, technické údaje odpovídají 1.5.2015  
/ producer has the right to make changes of technical data, technical data are valid on 1.5.2015 /  
- píla na fotografii není vždy v základním provedení, uvedené rozměry odpovídají stroji v základním provedení  
/ the machine in the picture is not always in the basic version, mentioned diameters are for machine in basic version /

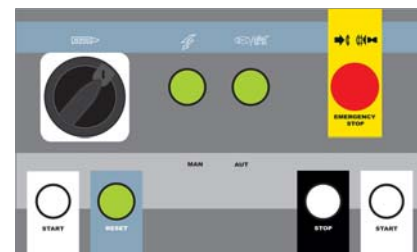

CONTROL PANEL:GH