











220x250 GHE-R

27x0,9

| |  0° |  45° |  60° |  60° |  |
|---|--|---|---|---|---|
|  | 220 | 160 | 90 | x | x |
|  | 120* | 85* | 55* | x | x |
|  | 230x150 | 160x90 | 90x90 | x | 230x120 |

| | | | | |
|---|--|---|---|---|
|  |  |  |  |  |
| 3x400V 50 Hz | 0,75/1,1 | 30/65 | 2450x27x0,9 | 235 |

| | | | | |
|------|-----|------|------|-----|
| L | B | Hmin | Hmax | V |
| 1410 | 600 | 1490 | 1750 | 930 |



220x250
GHE-R

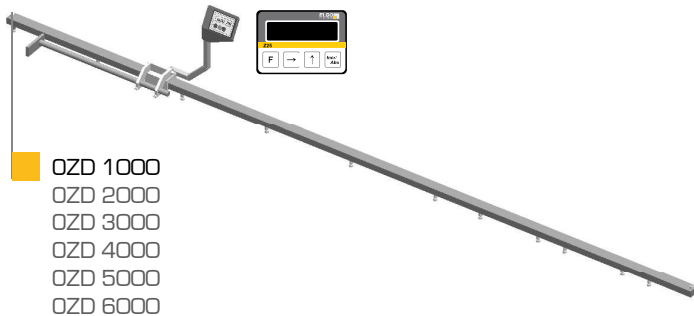
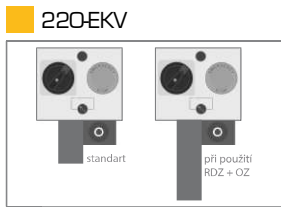

- OZD 1000
- OZD 2000
- OZD 3000
- OZD 4000
- OZD 5000
- OZD 6000

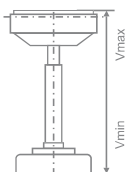
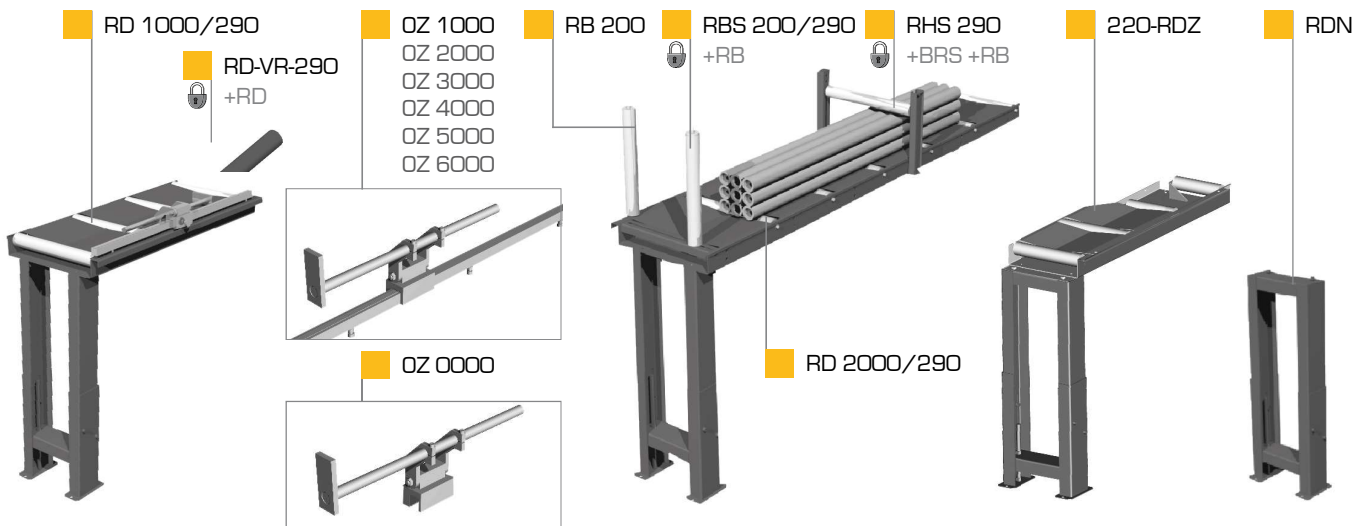

| | S (mm) | Vmin (mm) | Vmax (mm) |
|-------------|--------|-----------|-----------|
| R290 | 290 | 760 | 980 |

| | S (mm) | L (mm) | Vmin (mm) | Vmax (mm) | | |
|----------|--------|--------|-----------|-----------|---|-----|
| R | 290 | 1000 | 760 | 980 | 4 | 200 |
| | | 2000 | | | 7 | |

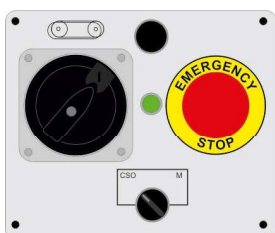
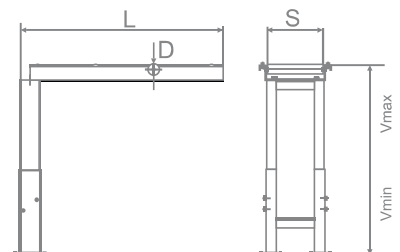

CONTROL PANEL: GH

220x250 GHE-R

- výrobce si vyhrazuje právo provádět změny technických údajů, technické údaje odpovídají 1.1.2020
/ producer has the right to make changes of technical data, technical data are valid on 1.1.2020

- pila na fotografii není vždy v základním provedení, uvedené rozměry odpovídají stroji v základním provedení
/ the machine in the picture is not always in the basic version, mentioned diameters are for machine in basic version

* doporučená hodnota. Při překročení doporučeného maximálního průměru není možné garantovat výkon pilového pásu!
/ recommended value. The blade performance cannot be guaranteed when the recommended diameter is exceeded!

- řezání svazků bez horního přitlaču
/ cutting of the bundle without top clamping