

WATERPROOF DIGITAL CALIPERS

ATTENTION: IT IS NECESSARY TO SET ZERO AFTER POWER ON EACH TIME

ATTENTION: NO DATA OUTPUT

IP67
WATERPROOF

- IP67 dust/waterproof
- Resolution: 0.01mm/0.0005"
- Button function: zero, on/off, mm/inch, ABS/REL, hold
- Battery CR2032
- Meet DIN862
- Made of stainless steel



1118-150BW

(mm)									
Code	Range	Accuracy	Thumb roller	L	a	b	c	d	
1118-150BW *	0-150mm/0-6"	±0.03mm	without	236	21	16	16	40	
1118-200BW *	0-200mm/0-8"	±0.03mm	without	286	24	19	16	50	
1118-300BW *	0-300mm/0-12"	±0.03mm	without	400	25	20.5	17	60	
1118-150B *	0-150mm/0-6"	±0.03mm	with	236	21	16	16	40	
1118-200B *	0-200mm/0-8"	±0.03mm	with	286	24	19	16	50	
1118-300B *	0-300mm/0-12"	±0.03mm	with	400	25	20.5	17	60	

* Supplied with manufacturer inspection certificate traceable to DKD Germany

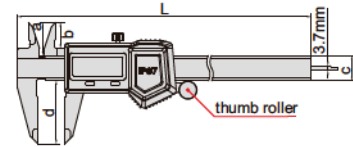

DIGITAL CALIPERS (ABSOLUTE CODE)

HIGH PRECISION

ABSOLUTE CODE

DATA OUTPUT

- Absolute code
- Resolution: 0.01mm/0.0005"
- Buttons: mm/inch, ABS/REL, on/off, origin set
- Battery CR2032, automatic power off
- After automatic power off, move the digital unit to turn on power
- Data output
- Meet DIN862
- Made of stainless steel
- Optional accessory: data output cable (code 7302-SPC4)



1103-150W

(mm)									
Code	Range	Accuracy	Thumb roller	L	a	b	c	d	
1103-150W *	0-150mm/0-6"	±0.02mm	without	234	20	15	16	40	
1103-200W *	0-200mm/0-8"	±0.02mm	without	286	24	19	16	50	
1103-300W *	0-300mm/0-12"	±0.03mm	without	390	26	21.5	16	60	
1103-150 *	0-150mm/0-6"	±0.02mm	with	234	20	15	16	40	
1103-200 *	0-200mm/0-8"	±0.02mm	with	286	24	19	16	50	
1103-300 *	0-300mm/0-12"	±0.03mm	with	390	26	21.5	16	60	

* Supplied with manufacturer inspection certificate traceable to DKD Germany

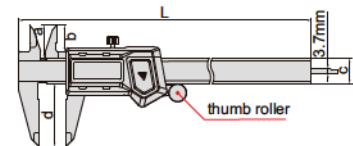

DIGITAL CALIPERS

ATTENTION: NO DATA OUTPUT

- Zinc alloy housing for digital unit
- Resolution: 0.01mm/0.0005"
- Buttons: zero, on/off, mm/inch
- Automatic power off, move the digital unit to turn on power
- Battery CR2032
- Meet DIN862
- Made of stainless steel



1114-150AW

(mm)									
Code	Range	Accuracy	Thumb roller	L	a	b	c	d	
1114-150AW *	0-150mm/0-6"	±0.03mm	without	236	21	16	16	40	
1114-200AW *	0-200mm/0-8"	±0.03mm	without	286	24	19	16	50	
1114-300AW *	0-300mm/0-12"	±0.03mm	without	400	25	20.5	17	60	
1114-150A *	0-150mm/0-6"	±0.03mm	with	236	21	16	16	40	
1114-200A *	0-200mm/0-8"	±0.03mm	with	286	24	19	16	50	
1114-300A *	0-300mm/0-12"	±0.03mm	with	400	25	20.5	17	60	

* Supplied with manufacturer inspection certificate traceable to DKD Germany

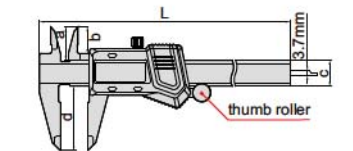

DATA OUTPUT

- Resolution: 0.01mm/0.0005"
- Buttons: on/off, zero, mm/inch
- Automatic power off, move the digital unit to turn on power
- Battery CR2032
- Data output
- Meet DIN862
- Made of stainless steel
- Optional accessory: data output cable (code 7306-20, 7302-SPC5A/SPC5B, 7305-SPC2A)

DIGITAL CALIPERS (STANDARD MODEL)



1108-150W

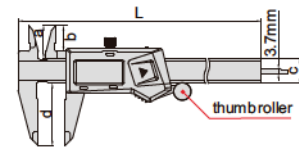

Code	Range	Accuracy	Thumb roller	L	a	b	c	d
1108-150W *	0-150mm/0-6"	±0.02mm	without	236	21	16	16	40
1108-200W *	0-200mm/0-8"	±0.03mm	without	286	24	19	16	50
1108-250W *	0-250mm/0-10"	±0.03mm	without	350	25	20.5	16	60
1108-300W *	0-300mm/0-12"	±0.03mm	without	400	25	20.5	16	60
1108-150 *	0-150mm/0-6"	±0.02mm	with	236	21	16	16	40
1108-200 *	0-200mm/0-8"	±0.03mm	with	286	24	19	16	50
1108-250 *	0-250mm/0-10"	±0.03mm	with	350	25	20.5	16	60
1108-300 *	0-300mm/0-12"	±0.03mm	with	400	25	20.5	16	60

* Supplied with manufacturer inspection certificate traceable to DKD Germany

LOCK READING WITH "HOLD" BUTTON

DATA OUTPUT

- Resolution: 0.01mm
- Buttons: on/off, zero, hold
- Automatic power off, move the digital unit to turn on power
- Battery CR2032
- Data output
- Meet DIN862
- Made of stainless steel
- Optional accessory: data output cable (code 7306-20, 7302-SPC5A/SPC5B, 7305-SPC2A)

METRIC DIGITAL CALIPERS



1109-150W

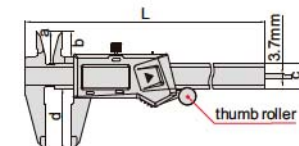

Code	Range	Accuracy	Thumb roller	L	a	b	c	d
1109-150W *	0-150mm	±0.03mm	without	236	21	16	16	40
1109-200W *	0-200mm	±0.03mm	without	286	24	19	16	50
1109-300W *	0-300mm	±0.03mm	without	400	25	20.5	16	60
1109-150 *	0-150mm	±0.03mm	with	236	21	16	16	40
1109-200 *	0-200mm	±0.03mm	with	286	24	19	16	50
1109-300 *	0-300mm	±0.03mm	with	400	25	20.5	16	60

* Supplied with manufacturer inspection certificate traceable to DKD Germany

DATA OUTPUT

- Resolution: 0.01mm/0.0005"
- Buttons: on/off, zero, mm/inch
- Automatic power off, move the digital unit to turn on power
- Battery CR2032
- Data output
- Meet DIN862
- Made of stainless steel
- Optional accessory: data output cable (code 7306-20, 7302-SPC5A/SPC5B, 7305-SPC2A)



round depth bar Ø1.6mm

DIGITAL CALIPERS WITH ROUND DEPTH BAR



1119-150W

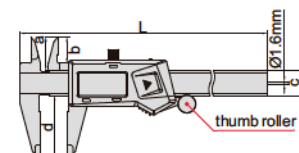

Code	Range	Accuracy	Thumb roller	L	a	b	c	d
1119-150W *	0-150mm/0-6"	±0.03mm	without	236	21	16	16	40
1119-150 *	0-150mm/0-6"	±0.03mm	with	236	21	16	16	40

* Supplied with manufacturer inspection certificate traceable to DKD Germany

DIGITAL CALIPERS WITH CARBIDE TIPPED JAWS

INSPECTION CERTIFICATE
TRACEABLE TO DKD

DATA OUTPUT

- Carbide tipped jaws for inside and outside measurements
- Resolution: 0.01mm/0.0005"
- Buttons: on/off, zero, mm/inch
- Automatic power off, move the digital unit to turn on power
- Battery CR2032, data output, meet DIN862
- Made of stainless steel
- Optional accessory: data output cable (code 7306-20, 7302-SPC5A/SPC5B, 7305-SPC2A)



1110-150AW

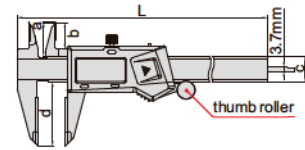

Code	Range	Accuracy	Thumb roller	L	a	b	c	d	(mm)
1110-150AW*	0-150mm/0-6"	±0.03mm	without	236	21	16	16	40	
1110-200AW*	0-200mm/0-8"	±0.03mm	without	286	24	19	16	50	
1110-300AW*	0-300mm/0-12"	±0.03mm	without	400	25	20.5	16	60	
1110-150A*	0-150mm/0-6"	±0.03mm	with	236	21	16	16	40	
1110-200A*	0-200mm/0-8"	±0.03mm	with	286	24	19	16	50	
1110-300A*	0-300mm/0-12"	±0.03mm	with	400	25	20.5	16	60	

* Supplied with manufacturer inspection certificate traceable to DKD Germany

DIGITAL CALIPERS WITH CERAMIC TIPPED JAWS

INSPECTION CERTIFICATE
TRACEABLE TO DKD

DATA OUTPUT

- Ceramic tipped jaws for outside measurement, extremely wear-resistant, non-magnetic, non-conductive
- Resolution: 0.01mm/0.0005"
- Buttons: on/off, zero, mm/inch
- Automatic power off, move the digital unit to turn on power
- Battery CR2032, data output, made of stainless steel
- Meet DIN862
- Optional accessory: data output cable (code 7306-20, 7302-SPC5A/SPC5B, 7305-SPC2A)



1193-150W

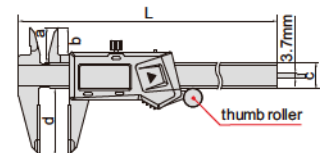

Code	Range	Accuracy	Thumb roller	L	a	b	c	d	(mm)
1193-150W*	0-150mm/0-6"	±0.03mm	without	235	21	16.5	16	40	
1193-200W*	0-200mm/0-8"	±0.03mm	without	297	24	20	16	50	
1193-300W*	0-300mm/0-12"	±0.03mm	without	390	26	21.5	16	60	
1193-150*	0-150mm/0-6"	±0.03mm	with	235	21	16.5	16	40	
1193-200*	0-200mm/0-8"	±0.03mm	with	297	24	20	16	50	
1193-300*	0-300mm/0-12"	±0.03mm	with	390	26	21.5	16	60	

* Supplied with manufacturer inspection certificate traceable to DKD Germany

LEFT HAND DIGITAL CALIPERS

INSPECTION CERTIFICATE
TRACEABLE TO DKD

DATA OUTPUT

- Designed for left handed users
- Resolution: 0.01mm/0.0005"
- Buttons: on/off, zero, mm/inch
- Automatic power off, move the digital unit to turn on power
- Battery CR2032
- Data output
- Meet DIN862
- Made of stainless steel
- Optional accessory: data output cable (code 7306-20, 7302-SPC5A/SPC5B, 7305-SPC2A)



1130-150W

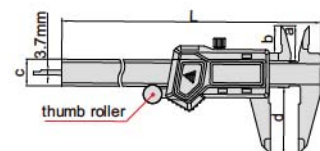

Code	Range	Accuracy	Thumb roller	L	a	b	c	d	(mm)
1130-150W*	0-150mm/0-6"	±0.03mm	without	236	21	16	16	40	
1130-200W*	0-200mm/0-8"	±0.03mm	without	286	24	19	16	50	
1130-300W*	0-300mm/0-12"	±0.03mm	without	400	25	20.5	16	60	
1130-150*	0-150mm/0-6"	±0.03mm	with	236	21	16	16	40	
1130-200*	0-200mm/0-8"	±0.03mm	with	286	24	19	16	50	
1130-300*	0-300mm/0-12"	±0.03mm	with	400	25	20.5	16	60	

* Supplied with manufacturer inspection certificate traceable to DKD Germany

MINI DIGITAL CALIPERS

- Resolution: 0.01mm/0.0005"
- Buttons: zero, mm/inch, on/off
- Automatic power off, move the digital unit to turn on power
- Battery LR44
- Meet DIN862
- Made of stainless steel



1111-100A

ATTENTION:
NO DATA OUTPUT

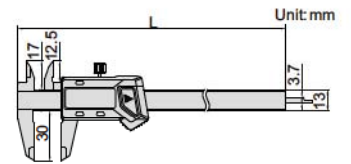

Code	Range	Accuracy	L
1111-75A	0-75mm/0-3"	±0.02mm	144mm
1111-100A	0-100mm/0-4"	±0.02mm	170mm

DATA
OUTPUT

DIGITAL CALIPERS

- Resolution: 0.01mm/0.0005"
- Buttons: on/off, zero, mm/inch
- Automatic power off, move the digital unit to turn on power
- Battery CR2032
- Data output
- Made of stainless steel
- Optional accessory: data output cable (code 7306-20, 7302-SPC5A/SPC5B, 7305-SPC2A)



1171-300

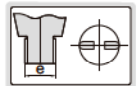
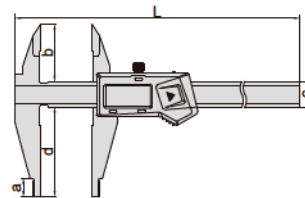

Code	Range	Accuracy	a	b	c	d	e	L
1171-200	0-200mm/0-8"	±0.03mm	12	38	17	60	10	320
1171-306	0-300mm/0-12"	±0.04mm	12	38	17	60	10	420
1171-300	0-300mm/0-12"	±0.04mm	12	38	17	90	10	420

DATA
OUTPUT

DIGITAL CALIPERS

- Resolution: 0.01mm/0.0005"
- Buttons: on/off, zero, mm/inch
- Automatic power off, move the digital unit to turn on power
- Battery CR2032
- Data output
- Made of stainless steel
- Optional accessory: data output cable (code 7306-20, 7302-SPC5A/SPC5B, 7305-SPC2A)



1170-300

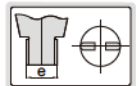
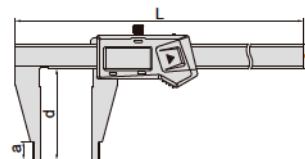

Code	Range	Accuracy	a	c	d	e	L
1170-200	0-200mm/0-8"	±0.03mm	12	17	60	10	320
1170-306	0-300mm/0-12"	±0.04mm	12	17	60	10	420
1170-300	0-300mm/0-12"	±0.04mm	12	17	90	10	420

PLASTIC DIGITAL CALIPER

- Made of hard plastic, non-magnetic and non-conductive
- Prevent workpieces from scratching by calipers
- Resolution: 0.01mm/0.0005"
- Buttons: on/off, zero, mm/inch
- Battery CR2032, automatic power off



1139-150

ATTENTION:
NO DATA OUTPUT

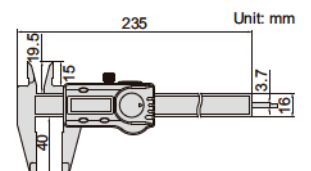

Code	Range	Accuracy
1139-150	0-150mm/0-6"	±0.1mm

DIAL CALIPERS

**INSPECTION
CERTIFICATE**
TRACEABLE TO DKD

**SHOCK
PROOF**

- Shockproof dial indicator
- Made of stainless steel



1312-150AW

Dial indicator graduation: 0.02mm

(mm)

Code	Range	Accuracy	Thumb roller	L	a	b	c	d	D	t
1312-150AW*	0-150mm	±0.03mm	without	235	21	16.5	16	40	Ø39	6.5
1312-200AW*	0-200mm	±0.03mm	without	288	24	19	16	48	Ø39	6.5
1312-300AW*	0-300mm	±0.03mm	without	410	28	22	20	62	Ø44.5	7.5
1312-150A*	0-150mm	±0.03mm	with	235	21	16.5	16	40	Ø39	6.5
1312-200A*	0-200mm	±0.03mm	with	288	24	19	16	48	Ø39	6.5
1312-300A*	0-300mm	±0.03mm	with	410	28	22	20	62	Ø44.5	7.5

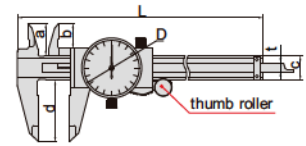

Dial indicator graduation: 0.01mm

(mm)

Code	Range	Accuracy	Thumb roller	L	a	b	c	d	D	t
1311-150AW*	0-150mm	±0.03mm	without	235	21	16.5	16	40	Ø39	6.5
1311-200AW*	0-200mm	±0.03mm	without	288	24	19	16	48	Ø39	6.5
1311-300AW*	0-300mm	±0.03mm	without	410	28	22	20	62	Ø44.5	7.5
1311-150A*	0-150mm	±0.03mm	with	235	21	16.5	16	40	Ø39	6.5
1311-200A*	0-200mm	±0.03mm	with	288	24	19	16	48	Ø39	6.5
1311-300A*	0-300mm	±0.03mm	with	410	28	22	20	62	Ø44.5	7.5

* Supplied with manufacturer inspection certificate traceable to DKD Germany

MINI VERNIER CALIPER

- Meet DIN862
- Made of stainless steel
- Satin chrome plated reading surface

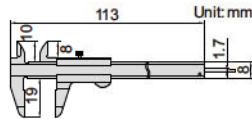

1204-70

Code	Range	Graduation	Accuracy
1204-70	0-70mm	0.05mm	±0.05mm

MINI VERNIER CALIPER

- Meet DIN862
- Made of stainless steel
- Satin chrome plated reading surface

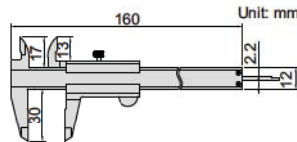

1203-1003

Code	Range	Graduation	Accuracy
1203-1003	0-100mm	0.05mm	±0.05mm

MINI VERNIER CALIPER

- Meet DIN862
- Made of stainless steel
- Satin chrome plated reading surface

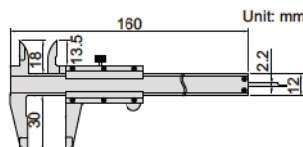

1201-1003

Code	Range	Graduation	Accuracy
1201-1003	0-100mm	0.05mm	±0.05mm

VERNIER CALIPERS

Graduation 0.05mm/1/128" (mm)

Code	Range	Accuracy	L	a	b	c	d
1205-150S	0-150mm/0-6"	±0.05mm	235	20.5	15.5	16	40
1205-200S	0-200mm/0-8"	±0.05mm	290	23.5	19	17	50
1205-250S	0-250mm/0-10"	±0.05mm	364	27.5	22	20	64
1205-300S	0-300mm/0-12"	±0.05mm	414	27.5	22	20	64



1205-150S

Graduation 0.05mm (mm)

Code	Range	Accuracy	L	a	b	c	d
1205-1503S	0-150mm	±0.05mm	235	20.5	15.5	16	40
1205-2003S	0-200mm	±0.05mm	290	23.5	19	17	50
1205-3003S	0-300mm	±0.05mm	414	27.5	22	20	64

Graduation 0.02mm/0.001" (mm)

Code	Range	Accuracy	L	a	b	c	d
1205-1502S	0-150mm/0-6"	±0.03mm	235	20.5	15.5	16	40
1205-2002S	0-200mm/0-8"	±0.03mm	290	23.5	19	17	50
1205-2502S	0-250mm/0-10"	±0.03mm	364	27.5	22	20	64
1205-3002S	0-300mm/0-12"	±0.03mm	414	27.5	22	20	64

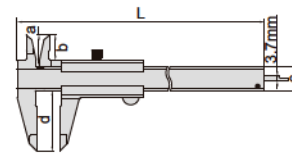

Graduation 0.02mm (mm)

Code	Range	Accuracy	L	a	b	c	d
1205-1501S	0-150mm	±0.03mm	235	20.5	15.5	16	40
1205-2001S	0-200mm	±0.03mm	290	23.5	19	17	50
1205-3001S	0-300mm	±0.03mm	414	27.5	22	20	64

- Meet DIN862
- Made of stainless steel
- Satin chrome plated reading surface

VERNIER CALIPER WITH ROUND DEPTH BAR

- Graduation 0.05mm/1/128"
- Round depth bar
- Meet DIN862
- Made of stainless steel
- Satin chrome plated reading surface



1202-150

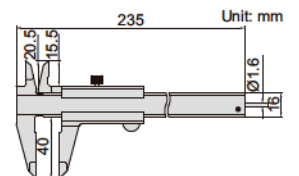

Code	Range	Accuracy
1202-150	0-150mm/0-6"	±0.05mm

VERNIER CALIPERS WITH FINE ADJUSTMENT

- Graduation 0.02mm/0.001"
- With fine adjustment
- Meet DIN862
- Made of stainless steel
- Satin chrome plated reading surface



1233-130

(mm)

Code	Range	Accuracy	L	a	b	c	d
1233-130	0-130mm/0-5"	±0.03mm	230	20.5	16.5	16	40
1233-180	0-180mm/0-7"	±0.03mm	295	23.5	19	16	50
1233-280	0-280mm/0-11"	±0.03mm	410	26	20	20	60

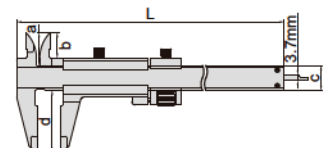

VERNIER CALIPERS WITH THUMB CLAMP

- Meet DIN862
- With thumb clamp
- Made of stainless steel
- Satin chrome plated reading surface

Graduation 0.05mm/1/128" (mm)

Code	Range	Accuracy	L	a	b	c	d
1223-150	0-150mm/0-6"	±0.05mm	230	20.5	16.5	16	40
1223-200	0-200mm/0-8"	±0.05mm	295	23.5	19	16	50
1223-300	0-300mm/0-12"	±0.05mm	405	26	20	20	60

Graduation 0.02mm/0.001" (mm)

Code	Range	Accuracy	L	a	b	c	d
1223-1502	0-150mm/0-6"	±0.03mm	230	20.5	16.5	16	40
1223-2002	0-200mm/0-8"	±0.03mm	295	23.5	19	16	50
1223-3002	0-300mm/0-12"	±0.03mm	405	26	20	20	60



1223-150

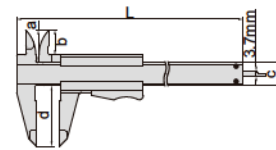

VERNIER CALIPERS WITH CARBIDE TIPPED JAWS

- Carbide tipped jaws for inside and outside measurements
- Meet DIN862
- Made of stainless steel
- Satin chrome plated reading surface

Graduation 0.05mm/1/128" (mm)

Code	Range	Accuracy	L	a	b	c	d
1238-150	0-150mm/0-6"	±0.05mm	230	21	16.5	16	40
1238-200	0-200mm/0-8"	±0.05mm	295	24	19	16	50
1238-300	0-300mm/0-12"	±0.05mm	410	25	20	17	60

Graduation 0.02mm/0.001" (mm)

Code	Range	Accuracy	L	a	b	c	d
1238-1502	0-150mm/0-6"	±0.03mm	230	21	16.5	16	40
1238-2002	0-200mm/0-8"	±0.03mm	295	24	19	16	50
1238-3002	0-300mm/0-12"	±0.03mm	410	25	20	17	60



1238-150

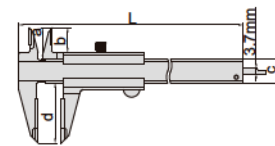

VERNIER CALIPER

- Graduation 0.02mm
- With fine adjustment
- Made of stainless steel
- Satin chrome plated reading surface



1217-3001

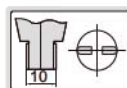
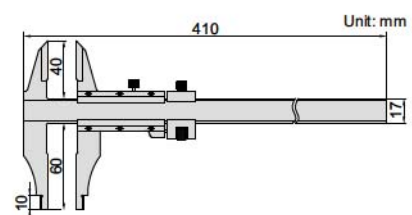

Code	Range	Accuracy
1217-3001	0-300mm	±0.03mm

ATTENTION:
NOT HARDENED

VERNIER CALIPERS (ANTI MAGNETIC)

- Suitable for magnetic parts
- Graduation: 0.02mm
- Made of stainless steel
- Satin chrome plated reading surface
- Measuring faces are not hardened, HRC18-22



1224-201

(mm)						
Code	Range	Accuracy	a	c	d	e L
1224-151	0-150mm	±0.04mm	10	17	50	10 250
1224-201	0-200mm	±0.04mm	10	17	50	10 300
1224-361	0-300mm	±0.04mm	10	17	60	10 400

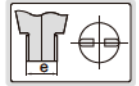
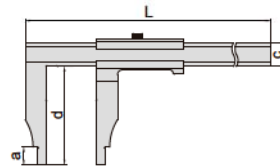

DEPTH BASE ATTACHMENTS

- To increase the stability of depth measurement
- Suitable for digital calipers and dial calipers
- Made of stainless steel

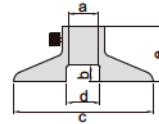
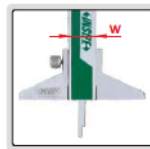

6140

(mm)						
Code	a	b	c	d	e	Application
6140	16.5	9	75	18	30	Suitable for calipers with beam width (w) 16mm
6140-300A	20	15	125	22	34	Suitable for calipers with beam width (w) 20mm

**ACCESSORY SET FOR DIGITAL CALIPERS
CODE 6144**



6144

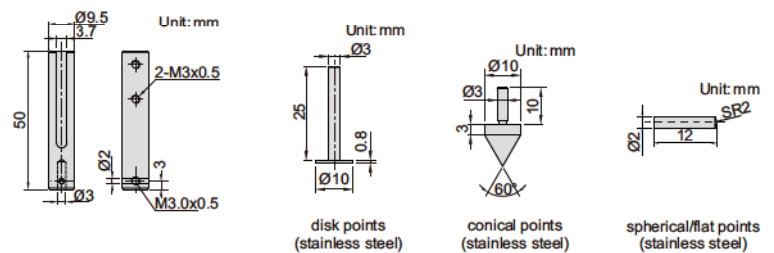

- Suitable for 0-150mm/0-6" and 0-200mm/0-8" digital calipers (thickness of lower jaws ≤ 3.7mm)

Code
6144

DIGITAL CALIPERS

Code	Range	Accuracy	a	c	d	e	L	(mm)
1106-301	0-300mm/0-12"	±0.05mm	18	24	100	20	420	
1106-302	0-300mm/0-12"	±0.05mm	18	24	150	20	420	
1106-451	0-450mm/0-18"	±0.05mm	18	24	100	20	625	
1106-501	0-500mm/0-20"	±0.05mm	18	24	100	20	675	
1106-502	0-500mm/0-20"	±0.06mm	18	24	150	20	675	
1106-503	0-500mm/0-20"	±0.06mm	24	31	200	20	675	
1106-505	0-500mm/0-20"	±0.08mm	24	42	300	20	675	
1106-601	0-600mm/0-24"	±0.05mm	18	24	100	20	770	
1106-602	0-600mm/0-24"	±0.06mm	18	24	150	20	770	
1106-603	0-600mm/0-24"	±0.06mm	24	31	200	20	770	
1106-802	0-800mm/0-32"	±0.07mm	24	31	150	20	1025	
1106-1002	0-1000mm/0-40"	±0.08mm	24	31	150	20	1220	
1106-1003	0-1000mm/0-40"	±0.08mm	24	31	200	20	1220	
1106-1005	0-1000mm/0-40"	±0.10mm	24	42	300	20	1220	
1106-1502	0-1500mm/0-60"	±0.11mm	24	42	150	20	1780	
1106-1503	0-1500mm/0-60"	±0.12mm	24	42	200	20	1780	
1106-2002	0-2000mm/0-80"	±0.14mm	24	42	150	20	2290	
1106-2003	0-2000mm/0-80"	±0.14mm	24	42	200	20	2290	
1106-2502	0-2500mm/0-100"	±0.22mm	24	42	150	20	2800	
1106-3002	0-3000mm/0-120"	±0.26mm	24	42	150	20	3300	



1106-501

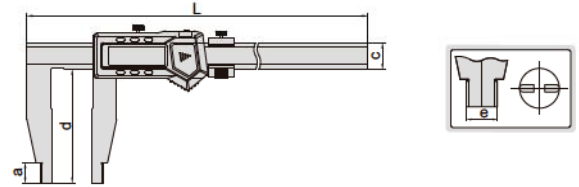

- Resolution: 0.01mm/0.0005"
- Button function: on/off, zero, mm/inch, ABS, data preset
- Battery CR2032
- Data output
- Made of stainless steel
- Optional accessory: data output cable (code 7306-20, 7302-SPC5A/SPC5B, 7305-SPC2A)

DATA OUTPUT

DIGITAL CALIPERS

- Resolution: 0.01mm/0.0005"
- Button function: on/off, zero, mm/inch, ABS, data preset
- Battery CR2032
- Data output
- Made of stainless steel
- Optional accessory: data output cable (code 7306-20, 7302-SPC5A/SPC5B, 7305-SPC2A)

Code	Range	Accuracy	a	b	c	d	e	L	(mm)
1117-301	0-300mm/0-12"	±0.05mm	18	56	24	100	20	420	
1117-501	0-500mm/0-20"	±0.05mm	18	56	24	100	20	675	
1117-502	0-500mm/0-20"	±0.06mm	18	56	24	150	20	675	
1117-601	0-600mm/0-24"	±0.05mm	18	56	24	100	20	770	
1117-802	0-800mm/0-32"	±0.07mm	24	67	31	150	20	1025	
1117-1002	0-1000mm/0-40"	±0.08mm	24	67	31	150	20	1220	



1117-501

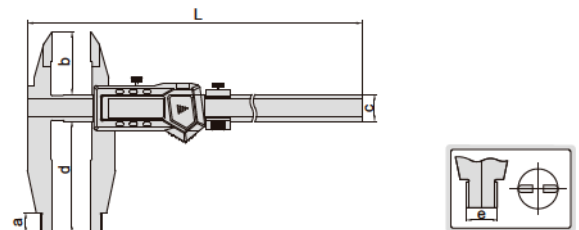

DATA OUTPUT

DIGITAL CALIPERS

- Resolution: 0.01mm/0.0005"
- Button function: on/off, zero, mm/inch, ABS, data preset
- Battery CR2032
- Data output
- Made of stainless steel
- Optional accessory: data output cable (code 7306-20, 7302-SPC5A/SPC5B, 7305-SPC2A)

Code	Range	Accuracy	a	b	c	d	e	L	(mm)
1136-301	0-300mm/0-12"	±0.05mm	18	45	24	100	20	420	
1136-451	0-450mm/0-18"	±0.05mm	18	45	24	100	20	625	
1136-501	0-500mm/0-20"	±0.05mm	18	45	24	100	20	675	
1136-502	0-500mm/0-20"	±0.06mm	18	45	24	150	20	675	
1136-503	0-500mm/0-20"	±0.06mm	24	60	31	200	20	675	
1136-601	0-600mm/0-24"	±0.05mm	18	45	24	100	20	770	
1136-1002	0-1000mm/0-40"	±0.08mm	24	60	31	150	20	1220	
1136-1502	0-1500mm/0-60"	±0.11mm	24	60	42	150	20	1780	
1136-2002	0-2000mm/0-80"	±0.14mm	24	60	42	150	20	2290	



1136-501

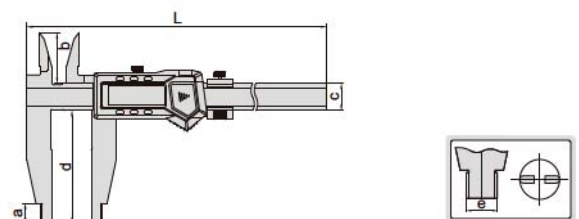

DATA OUTPUT

DIGITAL CALIPERS

DATA OUTPUT

- Resolution: 0.01mm/0.0005"
- Button function: on/off, zero, mm/inch, ABS, data preset
- Battery CR2032
- Data output
- Made of stainless steel
- Optional accessory: data output cable (code 7306-20, 7302-SPC5A/SPC5B, 7305-SPC2A)



1135-601

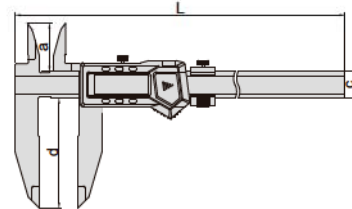

Code	Range	Accuracy	a	c	d	L
1135-451	0-450mm/0-18"	±0.05mm	45	24	100	625
1135-601	0-600mm/0-24"	±0.05mm	45	24	100	770
1135-1002	0-1000mm/0-40"	±0.08mm	60	31	150	1220

VERNIER CALIPERS (SOLID TYPE)

- With fine adjustment
- Made of stainless steel
- Satin chrome plated reading surface



1236-521

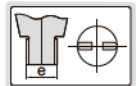
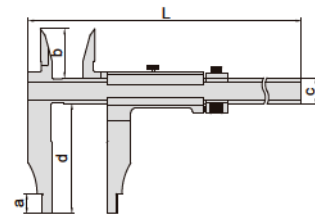

Graduation 0.05mm/1/128" (mm)

Code	Range	Accuracy	a	b	c	d	e	L
1236-394	0-300mm/0-12"	±0.07mm	12	38	20	90	10	450
1236-514	0-500mm/0-20"	±0.07mm	18	45	24	100	20	670
1236-524	0-500mm/0-20"	±0.08mm	18	45	24	150	20	670
1236-614	0-600mm/0-24"	±0.08mm	18	45	24	100	20	770
1236-824	0-800mm/0-32"	±0.09mm	24	60	31	150	20	1030
1236-1024	0-1000mm/0-40"	±0.12mm	24	60	31	150	20	1230

Graduation 0.02mm (mm)

Code	Range	Accuracy	a	b	c	d	e	L
1236-511	0-500mm	±0.05mm	18	45	24	100	20	670
1236-521	0-500mm	±0.06mm	18	45	24	150	20	670
1236-1021	0-1000mm	±0.08mm	24	60	31	150	20	1230

VERNIER CALIPERS (SOLID TYPE)

- Graduation 0.05mm/1/128"
- With fine adjustment
- Made of stainless steel
- Satin chrome plated reading surface



1207-514

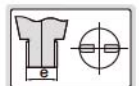
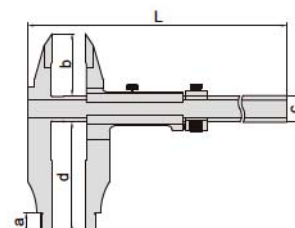

(mm)

Code	Range	Accuracy	a	b	c	d	e	L
1207-394	0-300mm/0-12"	±0.07mm	12	40	20	90	10	440
1207-514	0-500mm/0-20"	±0.07mm	18	56	24	100	20	670
1207-524	0-500mm/0-20"	±0.08mm	18	56	24	150	20	670
1207-824	0-800mm/0-32"	±0.09mm	24	67	31	150	20	930
1207-1024	0-1000mm/0-40"	±0.12mm	24	67	31	150	20	1230

VERNIER CALIPERS (SOLID TYPE)

Graduation 0.05mm/1/128" (mm)

Code	Range	Accuracy	a	c	d	e	L
1208-214	0-200mm/0-8"	±0.06mm	10	20	100	10	330
1208-394	0-300mm/0-12"	±0.07mm	10	20	90	10	410
1208-324	0-300mm/0-12"	±0.07mm	18	24	150	20	410
1208-524	0-500mm/0-20"	±0.08mm	18	24	150	20	670
1208-614	0-600mm/0-24"	±0.08mm	18	24	100	20	770
1208-624	0-600mm/0-24"	±0.09mm	18	24	150	20	770
1208-824	0-800mm/0-32"	±0.09mm	24	31	150	20	1030
1208-1024	0-1000mm/0-40"	±0.12mm	24	31	150	20	1230
1208-1524	0-1500mm/0-60"	±0.16mm	24	42	150	20	1820
1208-2024	0-2000mm/0-80"	±0.20mm	24	42	150	20	2330

Graduation 0.02mm (mm)

Code	Range	Accuracy	a	c	d	e	L
1208-511	0-500mm	±0.05mm	18	24	100	20	670
1208-521	0-500mm	±0.06mm	18	24	150	20	670
1208-1021	0-1000mm	±0.08mm	24	31	150	20	1230
1208-1521	0-1500mm	±0.11mm	24	42	150	20	1820



1208-511

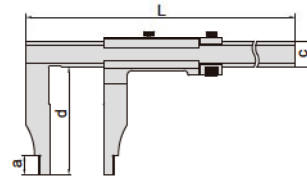

- With fine adjustment
- Made of stainless steel
- Satin chrome plated reading surface

VERNIER CALIPERS (SOLID TYPE)

- With fine adjustment
- Made of stainless steel
- Satin chrome plated reading surface

Graduation 0.05mm/1/128" (mm)

Code	Range	Accuracy	a	c	d	L
1210-614	0-600mm/0-24"	±0.08mm	45	24	100	770
1210-1024	0-1000mm/0-40"	±0.12mm	60	31	150	1230

Graduation 0.02mm (mm)

Code	Range	Accuracy	a	c	d	L
1210-611	0-600mm	±0.05mm	45	24	100	770
1210-1021	0-1000mm	±0.08mm	60	31	150	1230

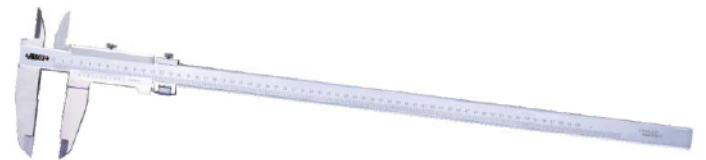

1210-611

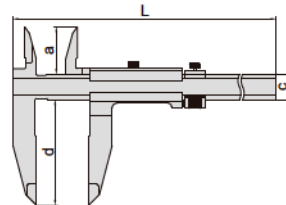

VERNIER CALIPERS

- With fine adjustment
- Made of stainless steel
- Satin chrome plated reading surface

Graduation 0.02mm/0.001" (mm)

Code	Range	Accuracy	a	c	d	e	L
1214-300	0-300mm/0-12"	±0.05mm	10	20	75	10	410
1214-450	0-450mm/0-18"	±0.05mm	18	24	100	20	620
1214-500	0-500mm/0-20"	±0.05mm	18	24	100	20	670
1214-600	0-600mm/0-24"	±0.05mm	18	24	100	20	770
1214-1000	0-1000mm/0-40"	±0.08mm	24	32	140	20	1216
1214-1500	0-1500mm/0-60"	±0.12mm	24	42	200	20	1830
1214-2000	0-2000mm/0-80"	±0.14mm	24	42	200	20	2320

Graduation 0.05mm/1/128" (mm)

Code	Range	Accuracy	a	c	d	e	L
1214-6004	0-600mm/0-24"	±0.08mm	18	24	100	20	770
1214-1004	0-1000mm/0-40"	±0.12mm	24	32	140	20	1216



1214-500

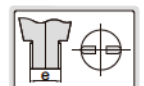
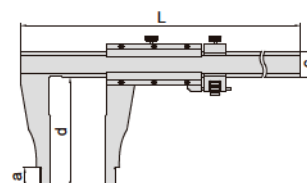

LONG JAW VERNIER CALIPERS

Graduation 0.02mm/0.001" (mm)

Code	Range	Accuracy	a	c	d	e	L
1215-392	0-300mm/0-12"	±0.05mm	10	17	90	10	410
1215-322	0-300mm/0-12"	±0.05mm	18	24	150	20	470
1215-522	0-500mm/0-20"	±0.06mm	18	24	150	20	670
1215-532	0-500mm/0-20"	±0.06mm	18	24	200	20	670
1215-622	0-600mm/0-24"	±0.06mm	18	24	150	20	770
1215-642	0-600mm/0-24"	±0.08mm	24	32	250	20	870
1215-822	0-800mm/0-32"	±0.07mm	24	32	150	20	1020
1215-832	0-800mm/0-32"	±0.07mm	24	32	200	20	1020
1215-1032	0-1000mm/0-40"	±0.08mm	24	32	200	20	1220
1215-1052	0-1000mm/0-40"	±0.11mm	24	42	300	20	1330
1215-3052	0-3000mm/0-120"	±0.26mm	24	50	300	20	3360

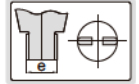
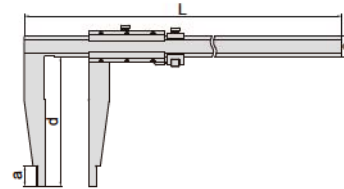

Graduation 0.05mm/1/128" (mm)

Code	Range	Accuracy	a	c	d	e	L
1215-524	0-500mm/0-20"	±0.08mm	18	24	150	20	670
1215-1034	0-1000mm/0-40"	±0.12mm	24	32	200	20	1330

- With fine adjustment
- Made of stainless steel
- Satin chrome plated reading surface

CUSTOM-MADE CALIPERS

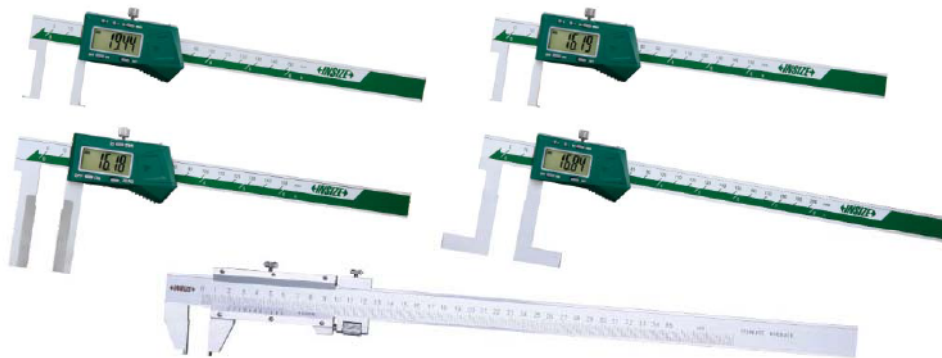

- We are able to make calipers according to the design from customers

SET BUTTON

- In some calipers, there is a "SET" button. It is possible to set a initial reading (instead of zero) on these calipers.
- For internal measurement, if the size L is unknown, it is necessary to set. After setting, you can get a direct reading, without adding L.
 Step 1: Find a micrometer, set it at a number (for example, 25mm) and lock it.
 Step 2: Press "SET", "+" and "-" buttons to set 25 on caliper. After setting, the initial reading will be 25 instead of zero, when "SET" is pressed anytime.
 Step 3: Put caliper into the micrometer, press "SET", the reading is 25.



- For external measurement, if the tips are spherical, it is difficult to set zero because the two tips may not be aligned.
 Step 1: Find a gage block (for example, 10mm).
 Step 2: Press "SET", "+" and "-" buttons to set 10mm on caliper. After setting, the initial reading will be 10mm instead of zero, when SET is pressed anytime.
 Step 3: Hold the gage block, press "SET", the reading is 10mm.



**UNIVERSAL CALIPER
CODE 1125-600**

DATA
OUTPUT



working with stands



working with measuring jaws



1125-600

- Buttons: on/off, set, mm/inch, ABS, preset (+, -)
- Automatic power off, move the digital unit to turn on power
- Battery CR2032
- Data output
- Made of stainless steel
- Optional accessory: data output cable (code 7306-20, 7302-SPC5A/SPC5B, 7305-SPC2A)

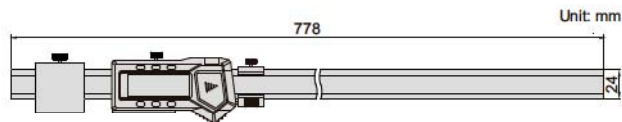

Code	Range*	Resolution	Accuracy
1125-600	0-600mm/0-24"	0.01mm/0.0005"	±0.05mm

*The range changes according to different points

Half disk points (included)

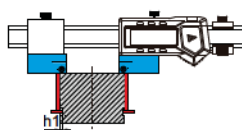
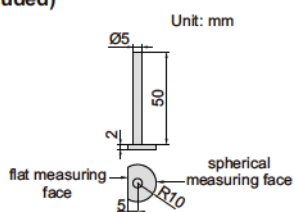

Measuring external groove diameter with flat measuring face (depth $h1 \leq 2.5\text{mm}$)

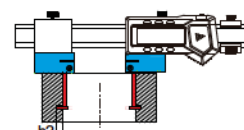

Measuring internal groove diameter with spherical measuring face (depth $h2 \leq 7.5\text{mm}$)

Conical points (optional)

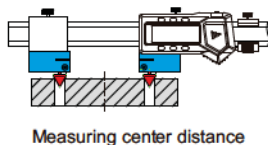
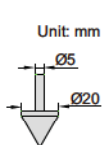

Measuring center distance

Code
1125-T101

Round shoulder points (optional)

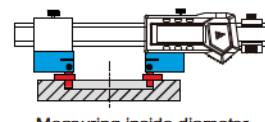
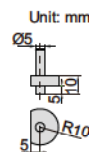

Measuring inside diameter

Code
1125-T102

Flat shoulder points (optional)

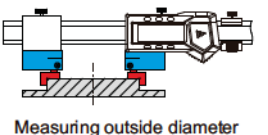
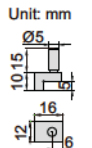

Measuring outside diameter

Code
1125-T103

Spherical points (included)

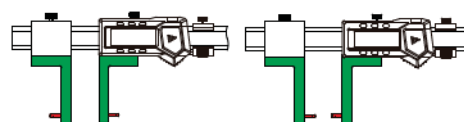
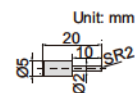

Point sleeve (optional)

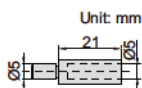
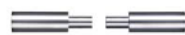

Code
1125-T104

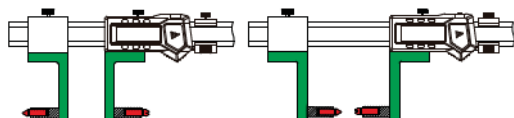

Working with multifunctional points, ball points and screw thread points

Stands (included)

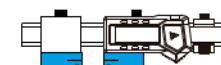
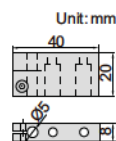

Measuring jaws (included)

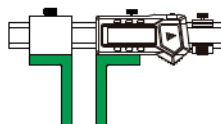
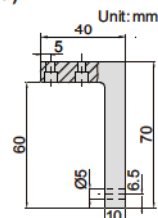

Depth stop (included)

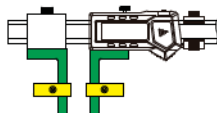
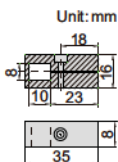

Multifunctional points 7392 (optional, next page)



Ball points 7391 (optional, next page)



Screw thread points 7381, 7321 (optional, next page)



DIGITAL CALIPER WITH INTERCHANGEABLE POINTS CODE 1526-200

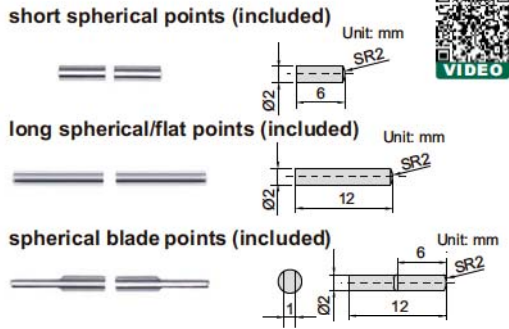

DATA OUTPUT

measure internal and external grooves

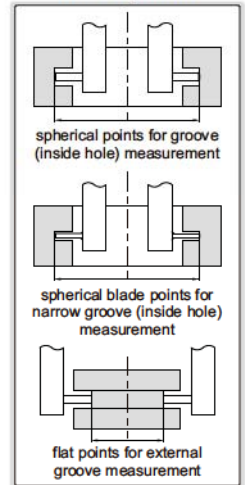

- Supplied with 3 pairs of points and zero setting block for external measurement
- Resolution: 0.01mm/0.0005"
- Buttons: on/off, set, mm/inch, preset (+, -)
- Automatic power off, move the digital unit to turn on power
- Battery CR2032
- Data output
- Made of stainless steel
- Optional accessory: points (code 1526-T101, 7392, 7391, 7381, 7321), depth stop (code 6143), data output cable (code 7306-20, 7302-SPC5A/SPC5B, 7305-SPC2A)

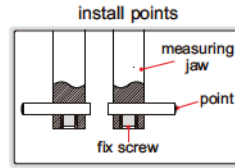
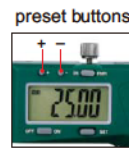
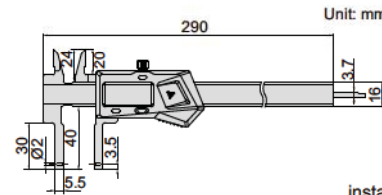

zero setting block for external measurement (included)



Point	Range	Accuracy	Application
short spherical points	12-212mm/0.5-8.5"(internal)	±0.03mm	for grooves inside small hole
long spherical/flat points	24-224mm/1-8.8"(internal) 0-187mm/0-7.5"(external)	±0.03mm	spherical points for grooves inside hole flat points for external grooves
spherical blade points	24-224mm/1-8.8"(internal) 0-187mm/0-7.5"(external)	±0.03mm	for narrow grooves inside hole

Depth stop (optional)

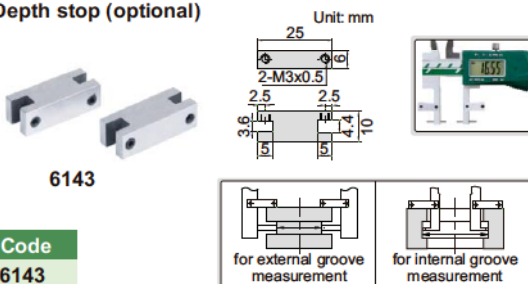

Multifunctional points (optional)

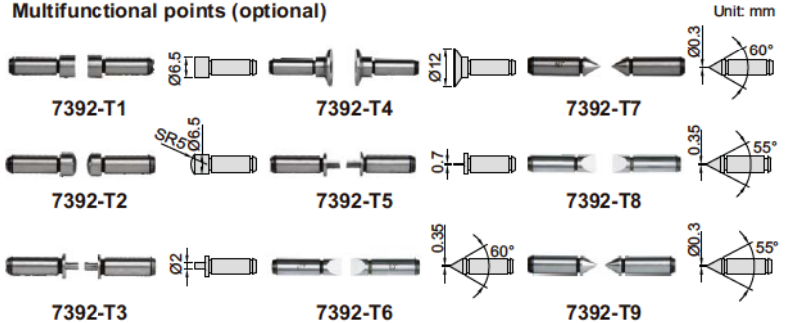

Code	Type	Code	Type	Code	Type
7392-T1*	flat	7392-T4*	disk	7392-T7*	point
7392-T2*	spherical	7392-T5*	blade	7392-T8*	knife-edge
7392-T3*	spline	7392-T6*	knife-edge	7392-T9*	point

* It is necessary to use point sleeve (code 1526-T101) for these points

Point sleeve (optional)

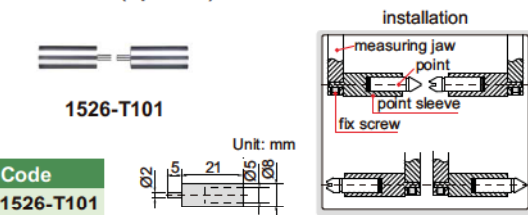

Screw thread points (optional)



Ball points (optional)

Unit: mm

Code	Ball dia.(D)	Module
7391-T3*	SØ2.0mm	1.25
7391-T4*	SØ2.5mm	1.5
7391-T5*	SØ3.0mm	1.75
7391-T6*	SØ3.5mm	2
7391-T7*	SØ4.0mm	2.25
7391-T8*	SØ4.5mm	2.5
7391-T9*	SØ5.0mm	2.75
7391-T10*	SØ6.0mm	3.5

Internal thread (60° thread angle)

Code	Pitch
7321-T11*	0.4-0.5mm/64-48TPI
7321-T12*	0.6-0.9mm/44-28TPI
7321-T13*	1-1.75mm/24-14TPI
7321-T14*	2-3mm/13-9TPI
7321-T15*	3.5-5mm/8-5TPI
7321-T16*	5.5-7mm/4.5-3.5TPI
7321-T1S*	6 pairs/set, including all above points

External thread (60° thread angle)

Code	Pitch
7381-T11*	0.4-0.5mm/64-48TPI
7381-T12*	0.6-0.9mm/44-28TPI
7381-T13*	1-1.75mm/24-14TPI
7381-T14*	2-3mm/13-9TPI
7381-T15*	3.5-5mm/8-5TPI
7381-T16*	5.5-7mm/4.5-3.5TPI
7381-TS*	6 pairs/set, including all above points

* It is necessary to use point sleeve (code 1526-T101) for these points

DIGITAL CALIPER WITH INTERCHANGEABLE POINTS CODE 1124-300A

DATA
OUTPUT



short spherical/flat points (included) Unit: mm

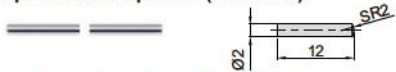

long spherical/flat points (included) Unit: mm



short spherical blade points (included) Unit: mm

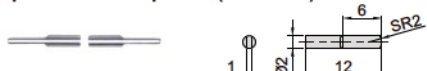

long spherical blade points (included) Unit: mm

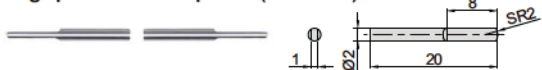

- Supplied with 4 pairs of points and zero setting block for external measurement
- Resolution: 0.01mm/0.0005"
- Buttons: on/off, set, mm/inch, preset (+, -)
- Automatic power off, move the digital unit to turn on power
- Battery CR2032
- Data output
- Made of stainless steel
- Optional accessory: points (code 1526-T101, 7392, 7391, 7381, 7321), depth stop (code 6143), data output cable (code 7306-20, 7302-SPC5A/SPC5B, 7305-SPC2A)



1124-300A

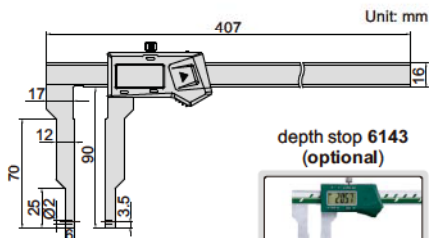

depth stop 6143 (optional)



install points

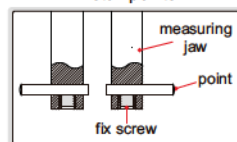

preset buttons

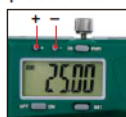

measure internal and external grooves

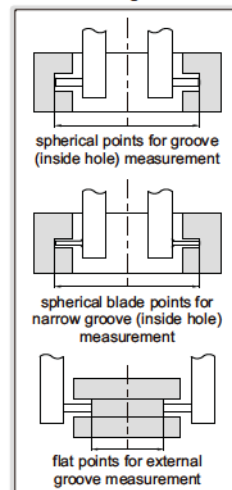

zero setting block for external measurement (included)



Point	Range	Accuracy	Application
short spherical/flat points	24-324mm/1-12.7"(internal) 0-288mm/0-11.3"(external)	±0.04mm	spherical points for grooves inside hole (small hole) flat points for external grooves
long spherical/flat points	40-340mm/1.5-13.3"(internal) 0-272mm/0-10.7"(external)	±0.04mm	spherical points for grooves inside hole (large hole) flat points for external grooves
short spherical blade points	24-324mm/1-12.7"(internal) 0-288mm/0-11.3"(external)	±0.04mm	for narrow grooves inside hole (small hole)
long spherical blade points	40-340mm/1.5-13.3"(internal) 0-272mm/0-10.7"(external)	±0.04mm	for narrow grooves inside hole (large hole)

Multifunctional points 7392 (optional, refer to 1526-200 for more details)



Ball points 7391 (optional, refer to 1526-200 for more details)



Screw thread points 7381, 7321 (optional, refer to 1526-200 for more details)



DIGITAL INSIDE GROOVE CALIPERS

DATA
OUTPUT



- Measure groove diameter
- Resolution: 0.01mm/0.0005"
- Buttons: on/off, set, mm/inch, preset (+, -)
- Automatic power off, move the digital unit to turn on power
- Battery CR2032
- Data output
- Made of stainless steel
- Optional accessory: depth stop (code 6143), data output cable (code 7306-20, 7302-SPC5A/SPC5B, 7305-SPC2A)

preset buttons



1120-150A

depth stop 6143 (optional)

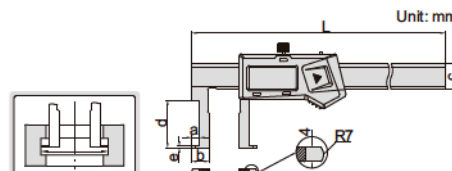

Code	Range	Accuracy	L	a	b	c	d	e
1120-150A	22-150mm	±0.04mm	250	5	11	16	30	1
1120-200A	25-200mm	±0.04mm	310	5	12.5	16	40	1
1120-300A	30-300mm	±0.05mm	410	5	15	17	50	1.5

DATA OUTPUT



DIGITAL INSIDE POINT CALIPERS

- Measure groove diameter
- Resolution: 0.01mm/0.0005"
- Buttons: on/off, set, mm/inch, preset (+, -)
- Automatic power off, move the digital unit to turn on power
- Battery CR2032
- Data output
- Made of stainless steel
- Optional accessory: depth stop (code 6143), data output cable (code 7306-20, 7302-SPC5A/SPC5B, 7305-SPC2A)

depth stop 6143 (optional)



1121-150A

Code	Range	Accuracy	L	a	b	c	d	D
1121-150A	24-150mm	±0.04mm	250	5	12	16	30	Ø2
1121-200A	25-200mm	±0.04mm	310	5	12.5	16	40	Ø2
1121-3001A	50-300mm	±0.06mm	410	8	25	17	80	Ø3

preset buttons

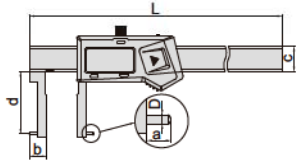
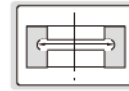

DATA OUTPUT

DIGITAL INSIDE GROOVE CALIPER

preset buttons

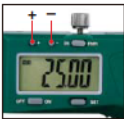

depth stop 6143 (optional)

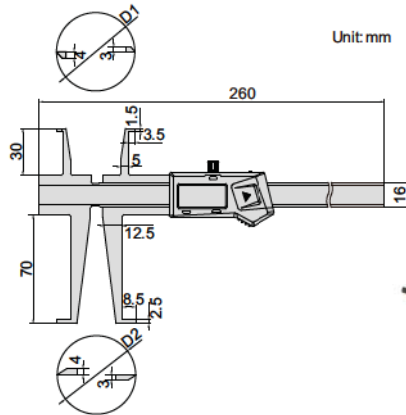

1176-150

- Measure diameter of grooves inside bores
- Resolution: 0.01mm/0.0005"
- Buttons: on/off, set, mm/inch, preset (+, -)
- Automatic power off, move the digital unit to turn on power
- Battery CR2032
- Data output
- Made of stainless steel
- Optional accessory: depth stop (code 6143), data output cable (code 7306-20, 7302-SPC5A/SPC5B, 7305-SPC2A)

sizes to be measured (use upper jaws)

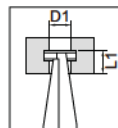

(mm)	
D1	L1
Ø9	<8
Ø10	<15
Ø11-150	<30

sizes to be measured (use lower jaws)

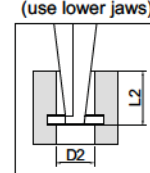

(mm)			
D2	L2	D2	L2
Ø15	<10	Ø19	<42
Ø16	<18	Ø20	<50
Ø17	<26	Ø21	<58
Ø18	<34	Ø22-150	<70

Code	Range of upper jaw	Range of lower jaw	Accuracy
1176-150	9-150mm/0.35-6"	15-150mm/0.59-6"	±0.04mm

DATA OUTPUT

DIGITAL INSIDE GROOVE CALIPER

- Measure diameter of grooves inside bores
- Resolution: 0.01mm/0.0005"
- Buttons: on/off, set, mm/inch, preset (+, -)
- Automatic power off, move the digital unit to turn on power
- Battery CR2032
- Data output
- Made of stainless steel
- Optional accessory: depth stop (code 6143), data output cable (code 7306-20, 7302-SPC5A/SPC5B, 7305-SPC2A)

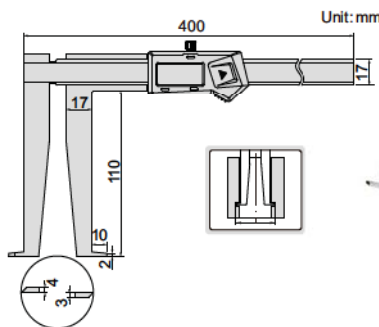

1178-300

preset buttons



depth stop 6143 (optional)



sizes to be measured

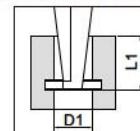

(mm)	
D1	L1
Ø25	<50
Ø26	<60
Ø27-300	<110

Code	Range	Accuracy
1178-300	25-300mm/1.18-12"	±0.05mm

DIGITAL INSIDE GROOVE CALIPER

- Measure diameter of grooves inside small bores
- Resolution: 0.01mm/0.0005"
- Buttons: on/off, set, mm/inch, preset (+, -)
- Automatic power off, move the digital unit to turn on power
- Battery CR2032
- Data output
- Made of stainless steel
- Optional accessory: depth stop (code 6143), data output cable (code 7306-20, 7302-SPC5A/SPC5B, 7305-SPC2A)



preset buttons



depth stop 6143 (optional)



1520-150

DATA OUTPUT

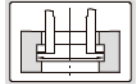
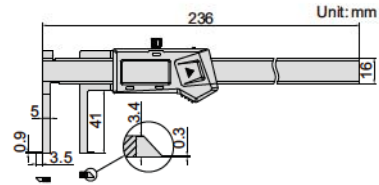

Code	Range	Accuracy
1520-150	11-150mm/0.43-6"	±0.04mm

DIGITAL OUTSIDE NECK CALIPER

- Measure grooves and recesses
- Resolution: 0.01mm/0.0005"
- Buttons: on/off, zero, mm/inch
- Automatic power off, move the digital unit to turn on power
- Battery CR2032
- Data output
- Made of stainless steel
- Optional accessory: depth stop (code 6143), data output cable (code 7306-20, 7302-SPC5A/SPC5B, 7305-SPC2A)

depth stop 6143 (optional)



1187-150A

DATA OUTPUT

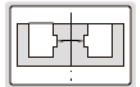
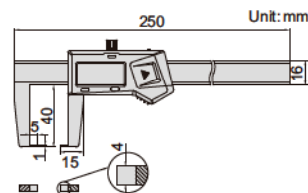

Code	Range	Accuracy
1187-150A	0-150mm/0-6"	±0.04mm

DIGITAL OUTSIDE POINT CALIPER

- Measure wall thickness inside bores and recesses
- Resolution: 0.01mm/0.0005"
- Buttons: on/off, zero, mm/inch
- Automatic power off, move the digital unit to turn on power
- Battery CR2032
- Data output
- Made of stainless steel
- Optional accessory: depth stop (code 6143), data output cable (code 7306-20, 7302-SPC5A/SPC5B, 7305-SPC2A)

depth stop 6143 (optional)



1185-150A

DATA OUTPUT

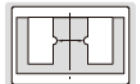
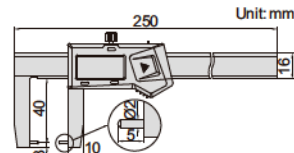

Code	Range	Accuracy
1185-150A	0-150mm/0-6"	±0.04mm

DEPTH STOP FOR CALIPERS

- Supplied in pair
- Made of stainless steel
- Suitable for caliper series 1124, 1526, 1520, 1176, 1178, 1120, 1121, 1187 and 1185

Application

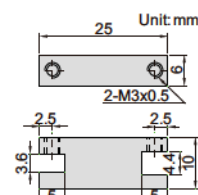
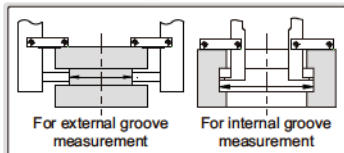

6143



Code
6143

DIGITAL BLADE CALIPERS

DATA OUTPUT

- The blade jaws fit into small grooves
- Resolution: 0.01mm/0.0005"
- Buttons: on/off, zero, mm/inch
- Automatic power off, move the digital unit to turn on power
- Battery CR2032
- Data output
- Made of stainless steel
- Optional accessory: data output cable (code 7306-20, 7302-SPC5A/SPC5B, 7305-SPC2A)



1188-150A

Code	Range	Accuracy	L	a	b	c	d	e	g
1188-150A	0-150mm/0-6"	±0.03mm	235	21	16.5	16	40	0.75	17
1188-200A	0-200mm/0-8"	±0.03mm	297	24	20	16	50	0.75	17
1188-300A	0-300mm/0-12"	±0.04mm	390	26	21.5	16	60	1.00	17

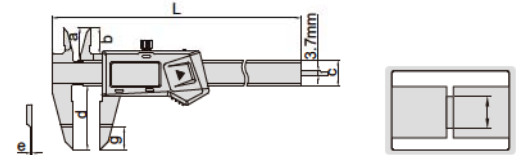

DIGITAL SMALL POINT CALIPER

DATA OUTPUT

- Small pointed jaws fit into small grooves and recesses
- Resolution: 0.01mm/0.0005"
- Buttons: on/off, zero, mm/inch
- Automatic power off, move the digital unit to turn on power
- Battery CR2032
- Data output
- Made of stainless steel
- Optional accessory: data output cable (code 7306-20, 7302-SPC5A/SPC5B, 7305-SPC2A)



1169-150

Code	Range	Accuracy
1169-150	0-150mm/0-6"	±0.03mm

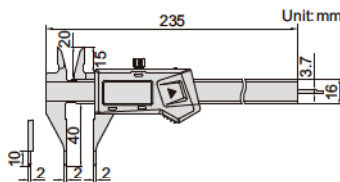

DIGITAL POINT CALIPER

DATA OUTPUT

- Pointed jaws fit into small grooves and recesses
- Resolution: 0.01mm/0.0005"
- Buttons: on/off, zero, mm/inch
- Automatic power off, move the digital unit to turn on power
- Battery CR2032
- Data output
- Made of stainless steel
- Optional accessory: data output cable (code 7306-20, 7302-SPC5A/SPC5B, 7305-SPC2A)



1183-150A

Code	Range	Accuracy
1183-150A	0-150mm/0-6"	±0.03mm

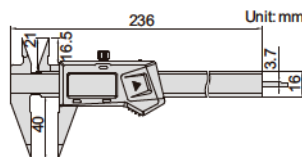

DIGITAL INSIDE KNIFE-EDGE CALIPER

DATA OUTPUT

- Measure diameter of deep step holes
- Resolution: 0.01mm/0.0005"
- Buttons: on/off, zero, mm/inch
- Automatic power off, move the digital unit to turn on power
- Battery CR2032
- Data output
- Made of stainless steel
- Optional accessory: data output cable (code 7306-20, 7302-SPC5A/SPC5B, 7305-SPC2A)



1123-150A

Code	Range	Accuracy
1123-150A	15-150mm/0.6-6"	±0.05mm

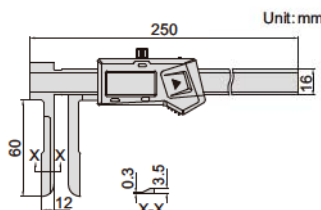

DIGITAL OFFSET CENTERLINE CALIPERS



DATA OUTPUT

- Measure hole center distance in the same or offset planes
- Resolution: 0.01mm/0.0005"
- Buttons: on/off, set, mm/inch, preset (+, -)
- Automatic power off, move the digital unit to turn on power
- Battery CR2032
- Data output
- Made of stainless steel
- Optional accessory: data output cable (code 7306-20, 7302-SPC5A/SPC5B, 7305-SPC2A)



1192-150A

Code	Range	Accuracy	c	ØD	L1	L2	L
1192-150A	10-150mm/0.4-6"	±0.05mm	16	10	32	65	236
1192-200A	10-200mm/0.4-8"	±0.07mm	16	10	32	65	286
1192-300A	10-300mm /0.4-12"	±0.09mm	16	10	32	65	396
1192-500A	20-500mm/0.8-20"	±0.09mm	24	20	48	88	686
1192-1000A	30-1000mm/1.2-40"	±0.12mm	31	30	48	88	1242
1192-1500A	30-1500mm/1.2-60"	±0.15mm	31	30	48	88	1745

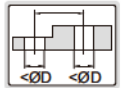
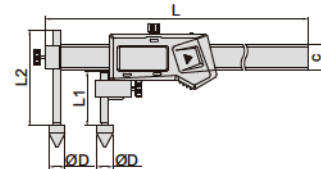

DIGITAL BACK-JAW CENTERLINE CALIPERS



DATA OUTPUT

- Measure hole center distance in the same or offset planes
- Resolution: 0.01mm/0.0005"
- Buttons: on/off, set, mm/inch, preset (+, -)
- Automatic power off, move the digital unit to turn on power
- Battery CR2032
- Data output
- Made of stainless steel
- Optional accessory: data output cable (code 7306-20, 7302-SPC5A/SPC5B, 7305-SPC2A)

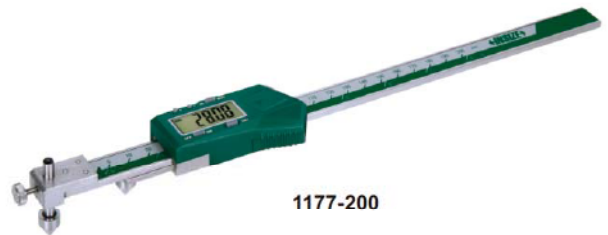

1177-200

Code	Range	Accuracy	ØD	c	L1	L2	L
1177-200	10-200mm/0.4-8"	±0.10mm	10	16	18	45	310
1177-300	10-300mm/0.4-12"	±0.10mm	10	16	18	45	410
1177-500	20-500mm/0.8-20"	±0.10mm	20	24	26	70	692
1177-1000	30-1000mm/1.2-40"	±0.12mm	30	31	39	70	1242
1177-1500	30-1500mm/1.2-60"	±0.15mm	30	31	39	70	1745

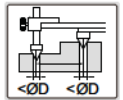
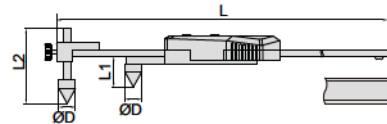

DIGITAL CENTERLINE/EDGE TO CENTER CALIPERS



DATA OUTPUT

- Measure hole center distance or edge to hole center distance
- Resolution: 0.01mm/0.0005"
- Buttons: on/off, set, mm/inch, preset (+, -)
- Automatic power off, move the digital unit to turn on power
- Battery CR2032
- Data output
- Made of stainless steel
- Optional accessory: data output cable (code 7306-20, 7302-SPC5A/SPC5B, 7305-SPC2A)



1525-300

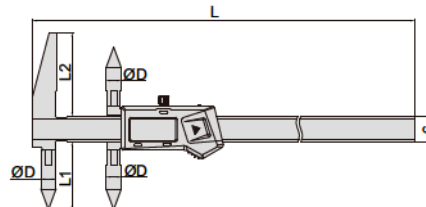

measure edge to hole center distance

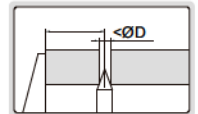

Code	Range of upper jaw (edge to center)	Range of lower jaw (center to center)	Accuracy	ØD	L1	L2	c	L
1525-300	5-300mm/0.2-12"	10-300mm/0.4-12"	±0.08mm	10	44.5	55	17	410
1525-500	10-500mm/0.4-20"	20-50mm/0.8-20"	±0.09mm	20	40	50	24	690
1525-1000	15-1000mm/0.6-40"	30-1000mm/1.2-40"	±0.12mm	30	60	70	31	1255
1525-1500	15-1500mm/0.6-60"	30-1500mm/1.2-60"	±0.15mm	30	60	70	31	1760

measure hole center distance

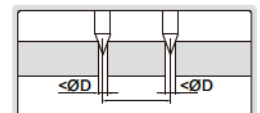



DIGITAL BACK-JAW EDGE TO CENTER CALIPERS

- Measure edge to hole center distance
- Resolution: 0.01mm/0.0005"
- Buttons: on/off, set, mm/inch, preset (+, -)
- Automatic power off, move the digital unit to turn on power
- Battery CR2032
- Data output
- Made of stainless steel
- Optional accessory: data output cable (code 7306-20, 7302-SPC5A/SPC5B, 7305-SPC2A)

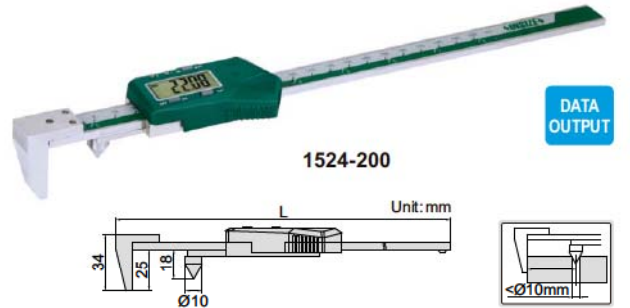

Code	Range	Accuracy	L (mm)
1524-200	5-200mm/0.2-8"	±0.1	310
1524-300	5-300mm/0.2-12"	±0.1	410

- Measure width of groove inside bores
- Resolution: 0.01mm/0.0005"
- Buttons: on/off, zero, mm/inch
- Automatic power off, move the digital unit to turn on power
- Battery CR2032
- Data output
- Made of stainless steel
- Optional accessory: data output cable (code 7306-20, 7302-SPC5A/SPC5B, 7305-SPC2A)



DIGITAL HOOK CALIPER

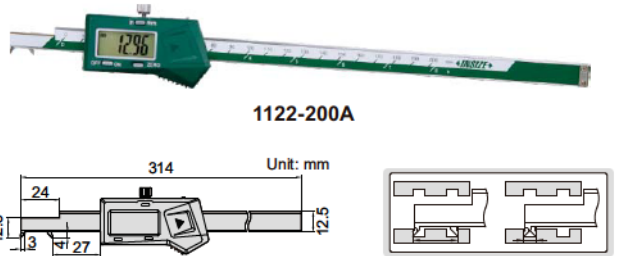

Code	Range	Accuracy
1122-200A	3-200mm/0.12-8"	±0.03mm



DIGITAL ARC RADIUS CALIPERS

- Measure the radius of arc less than half round
- Resolution: 0.01mm/0.0005"
- Buttons: on/off, zero, mm/inch
- Automatic power off, move the digital unit to turn on power
- Battery CR2032
- Data output
- Made of stainless steel
- Optional accessory: data output cable (code 7306-20, 7302-SPC5A/SPC5B, 7305-SPC2A)

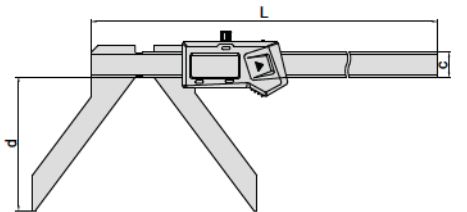

Code	Range (R)	Accuracy	L	c	d
1189-150B	5-150mm/0.2-6"	±0.05mm	263	16	65
1189-200B	5-200mm/0.2-8"	±0.07mm	313	16	85



DIGITAL OFFSET CALIPERS

- The left jaw can slide up and down to facilitate measurement of stepped sections
- Resolution: 0.01mm/0.0005"
- Buttons: on/off, zero, mm/inch
- Automatic power off, move the digital unit to turn on power
- Battery CR2032
- Data output
- Made of stainless steel
- Optional accessory: data output cable (code 7306-20, 7302-SPC5A/SPC5B, 7305-SPC2A)

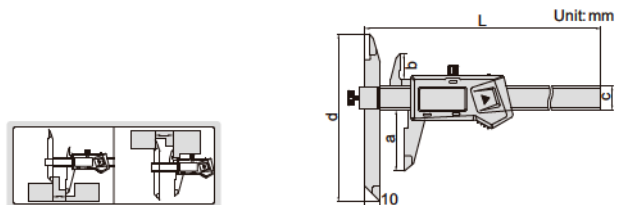

Code	Range	Accuracy	L	a	b	c	d
1186-150A	0-150mm/0-6"	±0.04mm	239	40	16.5	17	110
1186-200A	0-200mm/0-8"	±0.04mm	289	50	19.5	17	120
1186-300A	0-300mm/0-12"	±0.05mm	389	60	20.5	17	130

DIGITAL TUBE THICKNESS CALIPER

DATA OUTPUT

- Measure wall thickness of tubes
- Resolution: 0.01mm/0.0005"
- Buttons: on/off, zero, mm/inch
- Automatic power off, move the digital unit to turn on power
- Battery CR2032
- Data output
- Made of stainless steel
- Optional accessory: data output cable (code 7306-20, 7302-SPC5A/SPC5B, 7305-SPC2A)



1161-150A

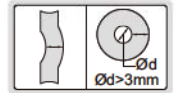
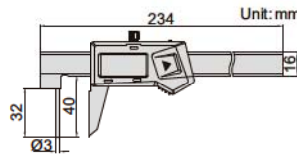

Code	Range	Accuracy
1161-150A	0-150mm/0-6"	±0.05mm

DIGITAL RTJ RING GROOVE CALIPERS

DATA OUTPUT

- Measure ring grooves of flange
- Resolution: 0.01mm/0.0005"
- Button function: on/off, set, zero, mm/inch, data preset
- Battery CR2032
- Data output
- Made of stainless steel
- Optional accessory: data output cable (code 7306-20, 7302-SPC5A/SPC5B, 7305-SPC2A)



1179-300

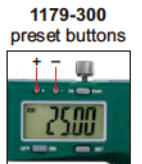

1179-600

measure outside diameter of RTJ ring groove

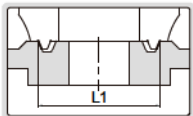

measure inside diameter of RTJ ring groove

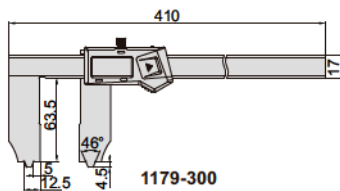
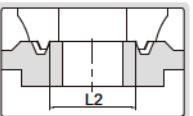

1179-300

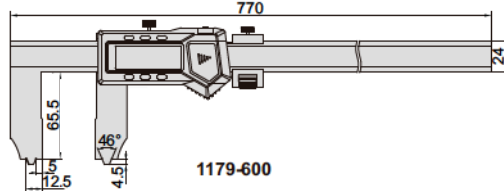

1179-600

applicable for RTJ ring grooves with angle 23°



10mm and 25mm need to be added on the reading

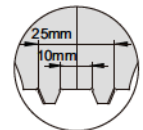

Code	Range (inside diameter of RTJ ring groove)	Range (outside diameter of RTJ ring groove)	Angle of RTJ ring groove	Accuracy
1179-300	10-300mm/0.4-12"	25-300mm/1-12"	23°	±0.06mm
1179-600	10-600mm/0.4-24"	25-600mm/1-24"	23°	±0.07mm

DIGITAL CRIMP HEIGHT CALIPER

RELATIVE PRODUCT: CRIMP HEIGHT MICROMETER (CODE 3266-25BA, 3566-25BA)

DATA OUTPUT

- Measure crimp height
- Resolution: 0.01mm/0.0005"
- Buttons: on/off, zero, mm/inch
- Automatic power off, move the digital unit to turn on power
- Battery CR2032
- Data output
- Meet DIN862
- Made of stainless steel
- Optional accessory: data output cable (code 7306-20, 7302-SPC5A/SPC5B, 7305-SPC2A)

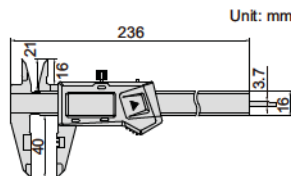

1165-150A

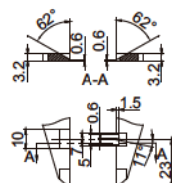

Code	Range	Accuracy
1165-150A	0-150mm/0-6"	±0.03mm

DATA OUTPUT

DIGITAL CALIPER WITH LARGE MEASURING FACES

- Measure diameter of wire ropes, and thickness of soft materials like rubber, sponge, etc.
- Resolution: 0.01mm/0.0005"
- Buttons: on/off, zero, mm/inch
- Automatic power off, move the digital unit to turn on power
- Battery CR2032
- Data output
- Made of stainless steel
- Optional accessory: data output cable (code 7306-20, 7302-SPC5A/SPC5B, 7305-SPC2A)

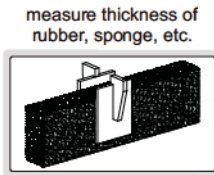
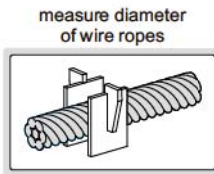

1172-200

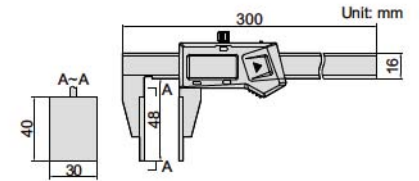

Code	Range	Accuracy
1172-200	0-200mm/0-8"	±0.07mm

DATA OUTPUT

DIGITAL GEAR TOOTH CALIPERS

- Resolution: 0.01mm/0.0005"
- Carbide tips
- Buttons: zero, on/off, mm/inch
- Battery LR44
- Data output
- Made of stainless steel
- Optional accessory: data output cable (code 7306-20, 7302-SPC1A/SPC1B, 7305-SPC2)

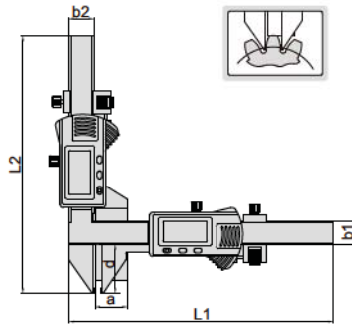

(mm)

Code	Range	Accuracy	L1	L2	a	b1	b2	d
1181-M25A	M1-25mm	±0.04mm	170	165.5	21	16	16	30.5
1181-M50A	M5-50mm	±0.04mm	220	190	50.5	16	16	55



1181-M25A

RELATIVE PRODUCT: DISK BRAKE MICROMETER (CODE 3288-, 3588-)

DATA OUTPUT

DIGITAL DISK BRAKE CALIPER

- Measure thickness of disk brakes
- Resolution 0.01mm/0.0005"
- Buttons: on/off, zero, mm/inch
- Automatic power off, move the digital unit to turn on power
- Battery CR2032
- Data output
- Made of stainless steel
- Optional accessory: data output cable (code 7306-20, 7302-SPC5A/SPC5B, 7305-SPC2A)

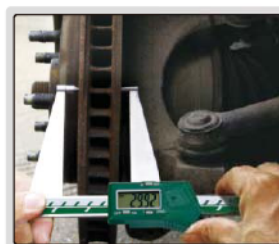

1162-125A

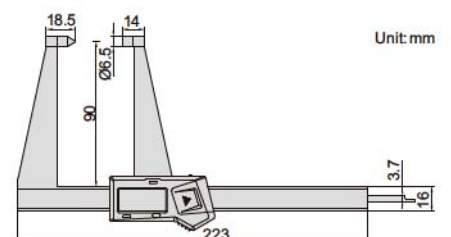

Code	Range	Accuracy
1162-125A	0-125mm/0-5"	±0.05mm

DIGITAL DISK BRAKE AND PAD CALIPER

- Measure thickness of disk brakes and pad wear
- Resolution: 0.01mm/0.0005"
- Buttons: on/off, zero, mm/inch
- Automatic power off, move the digital unit to turn on power
- Battery CR2032
- Data output
- Made of stainless steel
- Optional accessory: data output cable (code 7306-20, 7302-SPC5A/SPC5B, 7305-SPC2A)

RELATIVE PRODUCT: DISK BRAKE MICROMETER (CODE 3288-, 3588-)

DATA OUTPUT



1167-150A

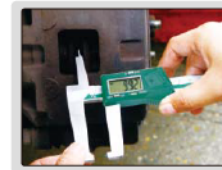
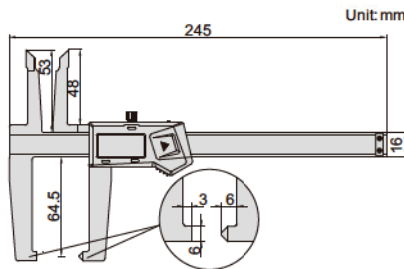

Code	Range	Accuracy
1167-150A	0-150mm/0-6"	±0.07mm

DIGITAL DRUM BRAKE CALIPER

- Measure internal and external diameter of drum brakes
- Resolution 0.01mm/0.0005"
- Buttons: on/off, zero, mm/inch
- Automatic power off, move the digital unit to turn on power
- Battery CR2032
- Data output
- Made of stainless steel
- Optional accessory: data output cable (code 7306-20, 7302-SPC5A/SPC5B, 7305-SPC2A)

RELATIVE PRODUCT: DISK BRAKE MICROMETER (CODE 3288-, 3588-)

DATA OUTPUT



1168-300A

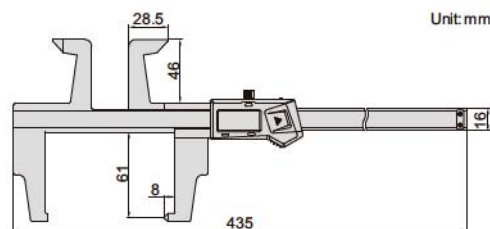
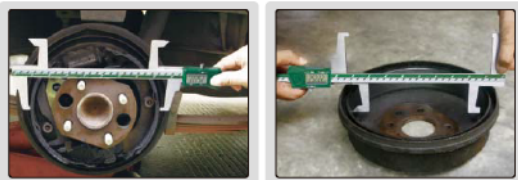

Code	Range	Accuracy
1168-300A	0-300mm/0-12"	±0.07mm

WATERPROOF DIGITAL DEPTH GAGES

ATTENTION: NO DATA OUTPUT

ATTENTION: IT IS NECESSARY TO SET ZERO AFTER POWER ON EACH TIME

IP67 WATERPROOF

- IP67 dust/waterproof
- Resolution: 0.01mm/0.0005"
- Button function: zero, on/off, mm/inch, ABS/REL, hold
- Meet DIN862
- Battery CR2032
- Made of stainless steel

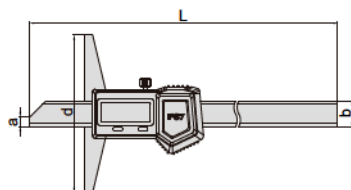

1149-150

Code	Range	Accuracy	(mm)			
			L	a	b	d
1149-150	0-150mm/0-6"	±0.03mm	240	6	16	100
1149-200	0-200mm/0-8"	±0.03mm	290	6	16	100
1149-300	0-300mm/0-12"	±0.03mm	390	6	16	150