

1
2
3
4
5
6
7

SPANNBACKEN-EINSÄTZE
CLAMPING INSERTS FOR MACHINE VISES

- Vertikale und horizontale Prismeneinsätze mit Spannstufe, gehärtet und geschliffen
- Prism inserts, vertical and horizontal prism, longitudinal recess, hardened and ground



Artikel Nr. Code No.	S	L1	L2	L3	L4	L5	L6	L7	L8	L9	L10	D	D1	Spannbereich ø vertikal	Spannbereich ø horizontal	Für Typ
														Clamping range ø vertically d1	Clamping range ø horizontally d2	For Type
398263310000	100	32,4	18	70	14	14,8	26	4	13,5	10,3	4,0	9	15	8-50	6-24	6512, 6537, 6530
398263320100	125	40,0	22	85	17	18,6	32	4	16,0	12,6	4,0	11	18	11-70	8-30	6512, 6537, 6530
398263330300	160	50,4	24	110	20	20,6	42	4	16,6	13,0	4,6	11	18	14-95	9-35	6512,6537 6515,6516 6530
398263340500	200	63,0	30	140	28	25,0	55	4	21,0	16,0	4,0	14	20	18-123	12-44	6512,6537 6515,6516 6522
398260598300	125	42,0	22	89	18	18,6	34	4	16,0	12,6	4,0	11	18	11-70	8-30	6515,6516

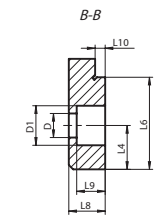
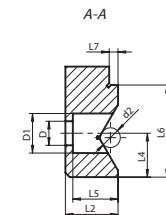
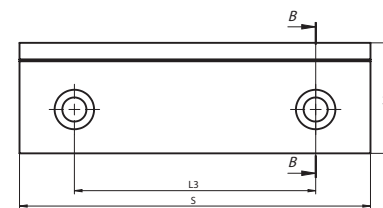
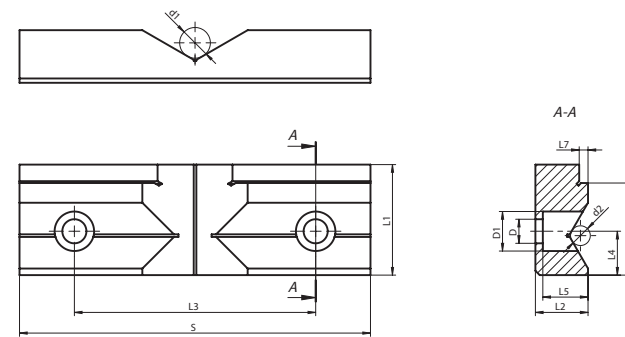

2-pc/satz • 2-pc/set

SPANNBACKEN-EINSÄTZE
CLAMPING INSERTS FOR MACHINE VISES

- Vertikale und horizontale Prismeneinsätze mit Spannstufe, gehärtet und geschliffen
- Prism inserts, vertical and horizontal prism, longitudinal recess, hardened and ground



Artikel Nr. Code No.	S	L1	L2	L3	L4	L6	L7	L8	L9	D	Spannbereich ø vertikal	Spannbereich ø horizontal	Für Typ
											Clamping range ø vertically d1	Clamping range ø horizontally d2	For Type
398263360900	100	32,4	18	63	14,0	26	4	13,5	4,0	M8	8-50	6-24	6517, 6518
398263370000	125	40,0	22	80	15,8	32	4	16,0	4,0	M10	11-70	8-30	6517, 6518
398263380200	160	50,4	24	100	20,0	42	4	16,6	4,6	M12	14-95	9-35	6517, 6518
398263390400	200	63,0	30	125	25,0	55	4	21,0	4,0	M12	18-123	12-44	6517, 6518

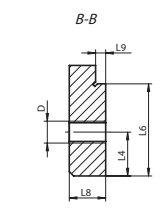
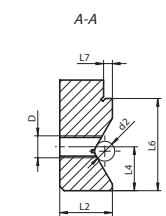
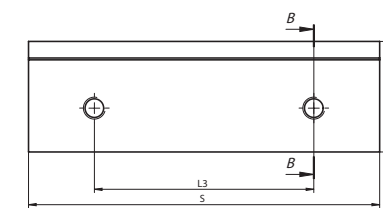
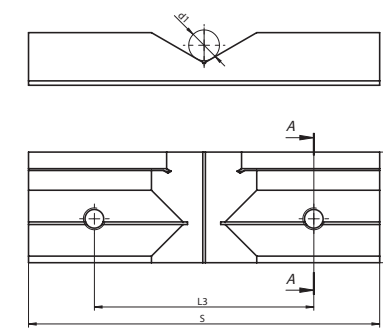

2-pc/satz • 2-pc/set