









## 600x1100 HORIZONTAL X

	$\perp$ 0°	$\nabla$ 45°	$\nabla$ 60°	$\nabla$ 45°	$\nabla$ 60°	$\frac{b}{a \times b}$
	620	620	500	650	490	x
	550*	400*	300*	400*	300*	x
	1100x600	750x600	500x600	740x600	470x600	1100 (700*)x400

					
3x400 V	5,5	20-100	9000x54x1,3		5200
Lmin	Lmax	B	Hmin	Hmax	V
4350	4700	2060	2650	2900	800

\*doporučené hodnoty/recommended values

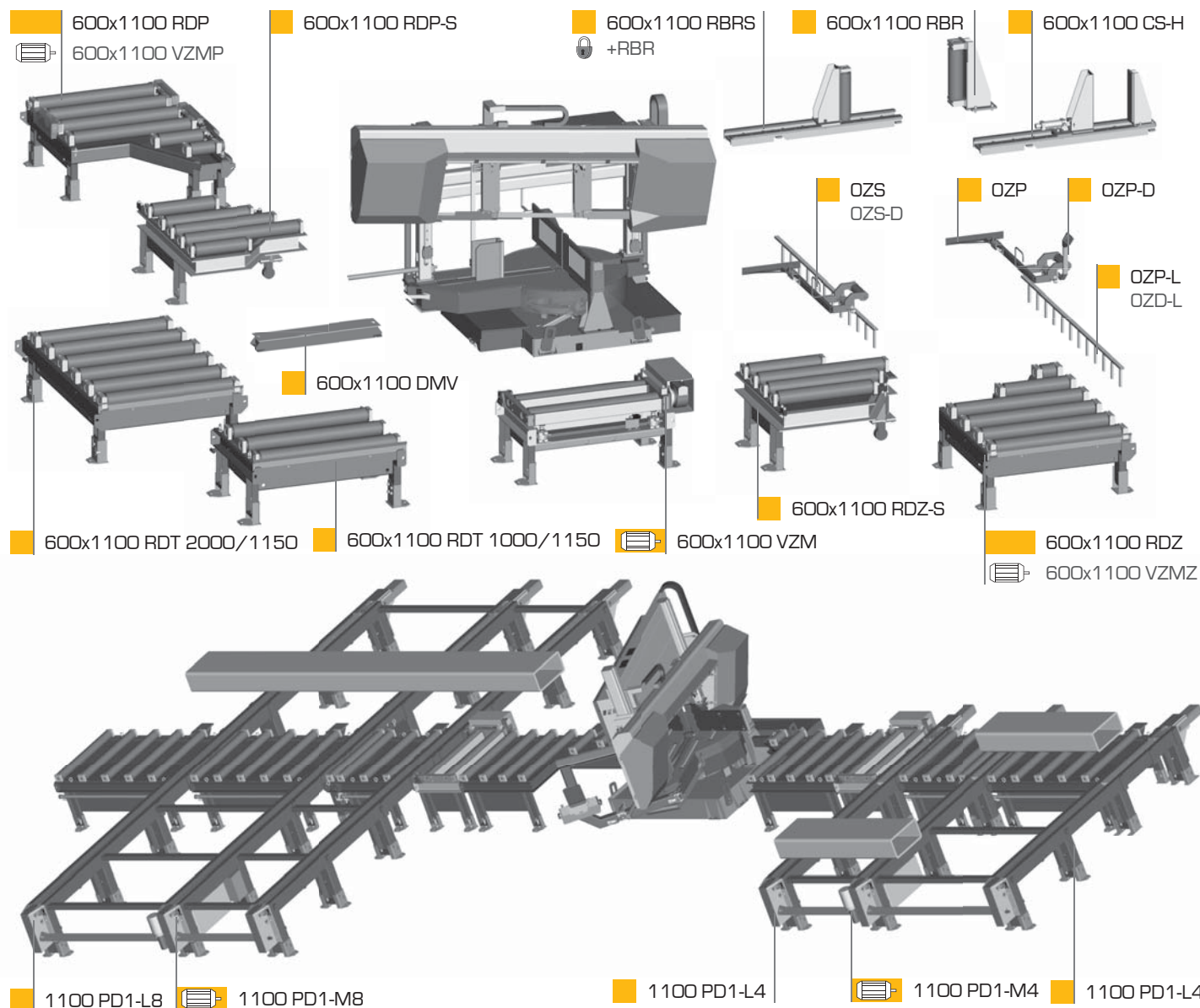
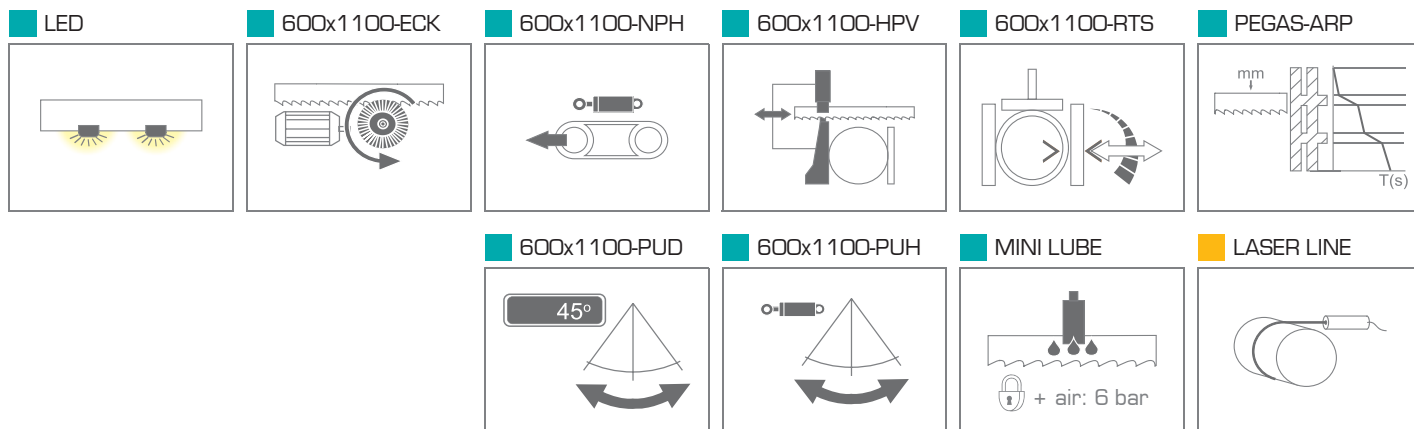

# 600x1100 HORIZONTAL X

STANDARD    OPTION



PEGAS-GONDA s.r.o., Čs.armády 322, 684 01 Slavkov u Brna, CZECH REPUBLIC  
Tel: 00420-544 221 125 (126), Fax: 00420-544 227 389, E-mail: pegas@gonda.cz  
www.pegas-gonda.cz

- výrobce si vyhrazuje právo provádět změny technických údajů, technické údaje odpovídají 1.5.2015  
/ producer has the right to make changes of technical data, technical data are valid on 1.5.2015 /  
- píla na fotografii není vždy v základním provedení, uvedené rozměry odpovídají stroji v základním provedení  
/ the machine in the picture is not always in the basic version, mentioned diameters are for machine in basic version /

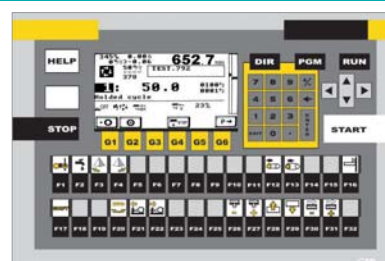

CONTROL PANEL: MAHLER (X)