

A (1:5)

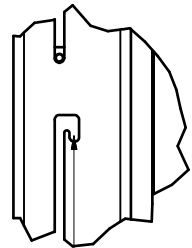

To hold the screen
i top position
Push the screen up in the lock
Screen weight: 12 kg

4xØ18 THRU

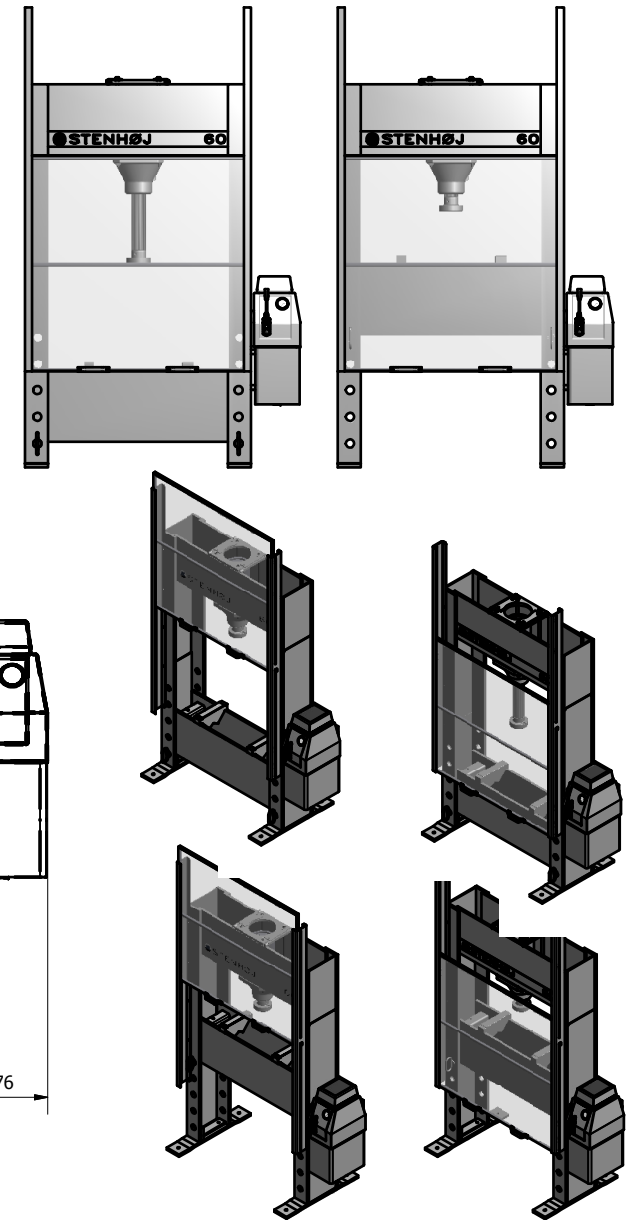
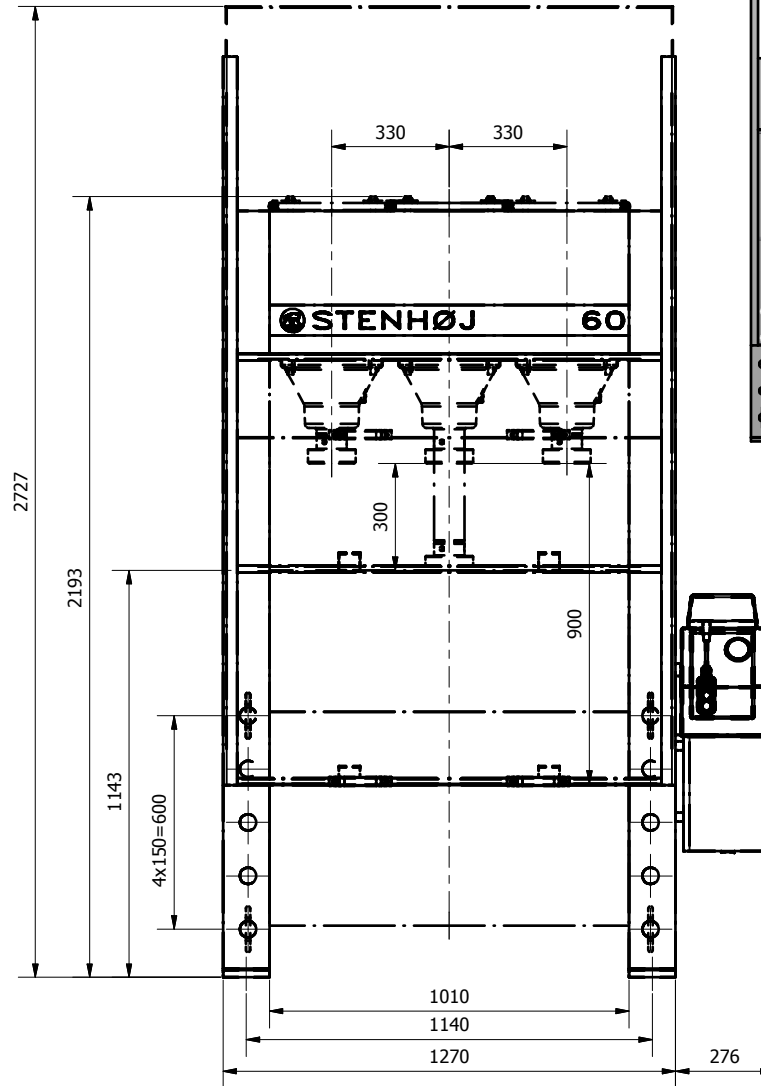
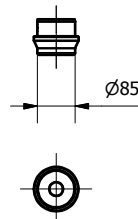
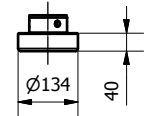
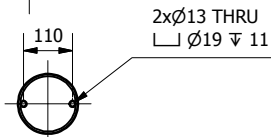
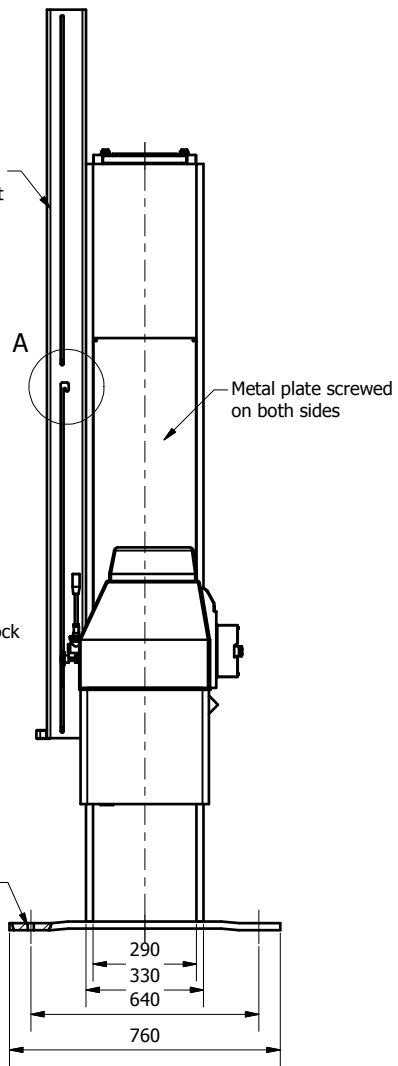

ALL-ROUND MACHINERY AND TOOL COMPANY	
<small>Akkermans Machinery and Tool Company Hendrikstraat 175 B • 4726 SR Heerle • Nederland T (+31) 165 30 41 88 • F (+31) 0165 30 47 58 • E info@amtc.eu • W www.amtc.eu</small>	
	MODEL FP60M-B
	SER.NO
	MODEL 400 V 50 HZ 2,5 KW
	DATE KG 790

Ikke angivne tolerancer efter DS/EN 22768-mK		Matr:	
Side nr.: 1 / 1	Vægt: 467,6 kg	Dato 03-02-2011	Sign. kje / kje
Benævnelse : FPS60M-B		Skala 1:12	Format A3
Lexan protection screen front		Tegnings-Nr.	Sidst gemt: 08-03-2010 12:53
 <small>DK: 7150 BARRIT TEL: +45 76 82 13 22 Fax: +45 76 82 13 00 E-mail: hydraulik@stenhoj.dk</small>		502495	